

(19) World Intellectual Property Organization
International Bureau



(43) International Publication Date
12 January 2006 (12.01.2006)

(10) International Publication Number
WO 2006/003664 A1

(51) International Patent Classification⁷: **GOIN 15/14**

Tzfaria, 60932 Moshav-Tzfaria (IL). KAUFMAN, Menachem [IL/IL]; 5 Kikar Gimmel, 49283 Petach-Tikva (IL).

(21) International Application Number:
PCT/IL2005/000719

(74) Agent: G. E. EHRlich (1995) LTD.; 11 Menachem Begin Street, 52 521 Ramat Gan (IL).

(22) International Filing Date: 6 July 2005 (06.07.2005)

(25) Filing Language: English

(81) Designated States (unless otherwise indicated, for every kind of national protection available): AE, AG, AL, AM, AT, AU, AZ, BA, BB, BG, BR, BW, BY, BZ, CA, CH, CN, CO, CR, CU, CZ, DE, DK, DM, DZ, EC, EE, EG, ES, FI, GB, GD, GE, GH, GM, HR, HU, ID, IL, IN, IS, JP, KE, KG, KM, KP, KR, KZ, LC, LK, LR, LS, LT, LU, LV, MA, MD, MG, MK, MN, MW, MX, MZ, NA, NG, NI, NO, NZ, OM, PG, PH, PL, PT, RO, RU, SC, SD, SE, SG, SK, SL, SM, SY, TJ, TM, TN, TR, TT, TZ, UA, UG, US, UZ, VC, VN, YU, ZA, ZM, ZW

(26) Publication Language: English

(30) Priority Data:
60/585,571 7 July 2004 (07.07.2004) US
10/938,951 13 September 2004 (13.09.2004) US
60/618,585 15 October 2004 (15.10.2004) US
60/625,096 5 November 2004 (05.11.2004) US

(71) Applicant (for all designated States except US): MOLECULAR CYTOMICS LTD. [CY/CY]; P.O. Box 21255, Nicosia, 1505 (CY).

(72) Inventors; and

(75) Inventors/Applicants (for US only): DEUTSCH, Mordechai [IL/TL]; 73 Moshav Olesh, 42855 Doar-Na Lev HaSharon (IL). DEUTSCH, Assaf [IL/IL]; 12 Moshav

(84) Designated States (unless otherwise indicated, for every kind of regional protection available): ARIPO (BW, GH, GM, KE, LS, MW, MZ, NA, SD, SL, SZ, TZ, UG, ZM, ZW), Eurasian (AM, AZ, BY, KG, KZ, MD, RU, TJ, TM), European (AT, BE, BG, CH, CY, CZ, DE, DK, EE, ES, FI, FR, GB, GR, HU, IE, IS, IT, LT, LU, LV, MC, NL, PL, PT,

[Continued on next page]

(54) Title: METHOD AND DEVICE FOR IDENTIFYING AN IMAGE OF A WELL IN AN IMAGE OF A WELL-BEARING COMPONENT

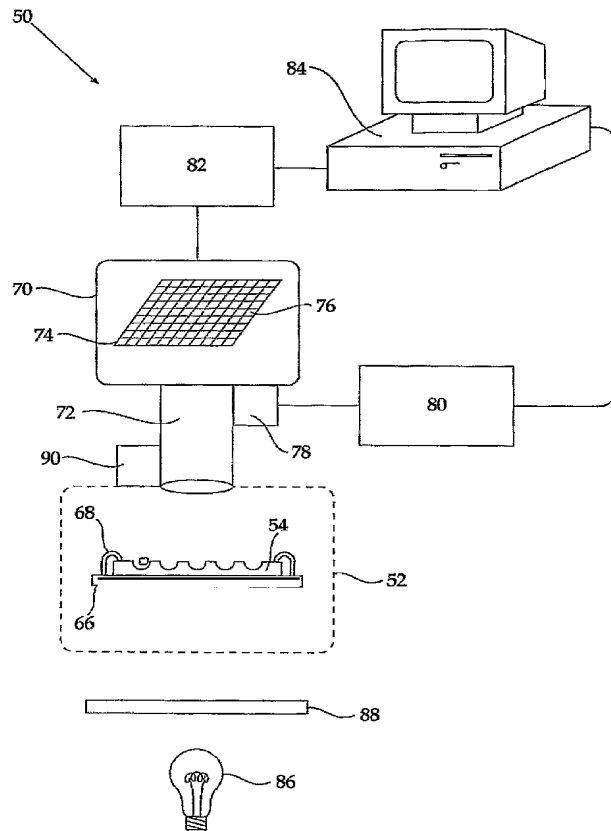

(57) Abstract: A method for identifying images of wells in an image of a well-bearing object such as multiwell plates or picowell carriers is disclosed using optical properties of the well-bearing object. An observation component, such as a camera, is used to approach focus of a focal point of a feature of the well-bearing component such as a well-bottom or well-wall or intersection of wells. An image of the focal point is acquired. The image of the focal point is then used as a reference point or used to define a reference point from which to identify the image of the well in the image of the well-bearing component and from which to delineate the borders of the well. In an aspect of the present invention, the well-bearing object is used as a wave-guide. Light escaping from a surface of the well-bearing object through discontinuous features such as well-intersections and well walls is used to delineate the borders of wells on the well-bearing object. Also disclosed is a multiwell device and a use thereof for the study of cells wherein bottoms of the wells are configured to focus light emitted from within a well and passing through the well bottom.

WO 2006/003664 A1



RO, SE, SI, SK, TR), OAPI (BF, BJ, CF, CG, CI, CM, GA, GN, GQ, GW, ML, MR, NE, SN, TD, TG).

For two-letter codes and other abbreviations, refer to the "Guidance Notes on Codes and Abbreviations" appearing at the beginning of each regular issue of the PCT Gazette.

Published:

- *with international search report*
- *before the expiration of the time limit for amending the claims and to be republished in the event of receipt of amendments*

- 1 -

METHOD AND DEVICE FOR IDENTIFYING AN IMAGE OF A WELL IN AN
IMAGE OF A WELL-BEARING COMPONENT

FIELD AND BACKGROUND OF THE INVENTION

5 The present invention relates to the field of cellular biology and more particularly, to an improved device and method for the study of cells. Specifically, the present invention is a method and a device for identification of the image of individual wells in an image of a well-bearing component so as to allow efficient image analysis and signal detection of cells held in the wells.

10 Many methods for the study of aggregates of living cells are known, but few methods provide information on individual cells that allow one to assess intercellular variability of a cell population, detect rare cells or cell subpopulations with distinct features, relate measured parameters to normal or abnormal cells. The extent of such variability is quite significant, see for example Bedner *et ai*, *Cytometry* 1998, 33, 1-9.

15 Combinatorial methods in chemistry, cellular biology and biochemistry are essential for the near simultaneous preparation of multitudes of active entities such as molecules. Once such a multitude of molecules is prepared, it is necessary to study the effect of each one of the active entities on a living organism. The study of the effects of stimuli such as exposure to active entities on living organisms is preferably initially
20 performed on living cells. Since cell-functions include many interrelated pathways, cycles and chemical reactions, the study of an aggregate of cells, whether a homogenous or a heterogeneous aggregate, does not provide sufficiently detailed or interpretable results: rather a comprehensive study of the biological activity of an active entity may be advantageously performed by examining the effect of the active entity on a single
25 isolated living cells. Thus, the use of single-cell assays is one of the most important tools for understanding biological systems and the influence thereupon of various stimuli such as exposure to active entities.

 The combinatorial preparation of a multitudes of active entities coupled with the necessity of studying the effect of each one of the active entities on living organisms
30 using a single-cell assay, requires the development of high-throughput single live cell assays. There is a need for the study of real-time responses to treatment in large and heterogeneous cell populations at an individual cell level. In such studies it is essential

- 2 -

to have the ability to define multiple characteristics of each individual cell, as well as the individual cell response to the experimental intervention of interest.

In the art, various different methods for studying living cells are known.

Multiwell plates having 6, 12, 48, 96, 384 or even 1536 wells on a standard *ca.*
5 8.5 cm by *ca.* 12.5 cm footprint are well known in the art. Such multiwell plates are provided with an $2n$ by $3n$ array of rectangular packed wells, n being an integer. The diameter of the wells of a plate depends on the number of wells and is generally greater than about 250 microns (for a 1536 well plate). The volume of the wells depends on the number of wells and the depth thereof but generally is greater than 5×10^{-6} liter (for a
10 1536 well plate). The standardization of the formats of multiwell plates is a great advantage for researchers as the standardization allows the production of standardized products including robotic handling devices, automated sample handlers, sample dispensers, plate readers, observation components, plate washers, software and such accessories as multifilters.

15 Multiwell plates are commercially available from many different suppliers. Multiwell plates made from many different materials are available, including glass, plastics, quartz and silicon. Multiwell plates having wells where the inside surface is coated with various materials, such as active entities, are known.

Although exceptionally useful for the study of large groups of cells, multiwell
20 plates are not suitable for the study of individual cells or even small groups of cells due to the large, relative to the cellular scale, size of the wells. Cells held in such wells either float about a solution or adhere to a well surface. When cells float about in a well, specific individual cells are not easily found for observation. When cells adhere to a well surface, the cells adhere to any location in the well, including anywhere on the
25 bottom of the well and on the walls of the well. Such variability in location makes high-throughput imaging (for example for morphological studies) challenging as acquiring an individual cell and focusing thereon is extremely difficult. Such variability in location also makes high-throughput signal processing (for example, detection of light emitted by a single cell through fluorescent processes) challenging as light must be gathered
30 from the entire area of the well, decreasing the signal to noise ratio. Further, a cell held in a well of a multiwell plate well can be physically or chemically manipulated (for example, isolation or movement of a single selected cell or single type of cell, changing media or introducing active entities) only with difficulty. Further, the loading of

- 3 -

multiwell plates as expressed in terms of cells held singly in the wells per unit area is very low (about 1536 cells in 65 cm², or 24 cells cm⁻²) Thus, multiwell plates are in general only suitable for the study of homogenous or heterogenous aggregates of cells as a group.

5 An additional disadvantage of multiwell plates is during the study of cells undergoing apoptosis. One method of studying cells is by exposing cells in a monolayer of cells adhered to the bottom of the well of a multiwell plate to a stimulus. Since one of the most important processes that a cell potentially undergoes is apoptosis, it is desirable to observe a cell throughout the apoptosis process. However, once a cell begins the
10 apoptosis process, the cell does not adhere to the bottom of the well: the cell detaches from the bottom and is carried away by incidental currents in the well. The cell is no longer observable and its identity lost.

An additional disadvantage of multiwell plates is in the study of non-adhering cells. Just as cells undergoing apoptosis, in multiwell plates non-adhering cells can be
15 studied as individuals only with difficulty. Considering that non-adhering cells are crucial for research in drug discovery, stem cell therapy, cancer and immunological diseases detection, diagnosis, therapy this is a major disadvantage. For example, blood contains seven heterogeneous types of non-adherent cells, all which perform essential functions, from carrying oxygen to providing immunity against disease.

20 In the art, a number of method and devices have been developed for the study of individual cells or a small number of cells as a group. Many such methods are based on using picowell-bearing device. A picowell-bearing device is a device for the study of cells that has at least one picowell-bearing component for study of cells. A picowell-bearing component is a component having at least one, but generally a plurality of
25 picowells, each picowell configured to hold at least one cell. The term "picowell" is general and includes such features as dimples, depressions, tubes and enclosures. Since cells range in size from about 1 microns to about 100 (or even more) microns diameter there is no single picowell size that is appropriate for holding a single cell of any type. That said, the dimensions of the typical individual picowell in the picowell-bearing
30 components known in the art have dimensions of between about 1 microns up to about 200 microns, depending on the exact implementation. For example, a device designed for the study of single isolated 20 micron cells typically has picowells of dimensions of about 20 microns, in other cases, larger picowells are used to study the interactions of a

- A -

few cells held together in one picowell. For example, a 200 micron picowell is recognized as being useful for the study of the interactions of two or three cells, see PCT patent application ILO 1/00992 published as WO 03/035824 of the inventor.

One feature that increases the utility of a picowell-bearing device is that each individual picowell is individually addressable. By individual addressability is meant that each picowell can be registered, found or studied without continuous observation. For example, while cells are held in the picowells of a picowell-bearing component, each cell is characterized and the respective picowell where that cell is held is noted. When desired, the observation component of the picowell-bearing device is directed to the location of the picowell where a specific cell is held. One method of implementing individual addressability is by the use of fiducial points or other features (such as signs or labels), generally on the picowell-bearing component. Another method of implementing individual addressability is by arranging the picowells in a picowell-array and finding a specific desired picowell by counting. Another method of implementing individual addressability is by providing a dedicated observation component for each picowell.

In the art, the picowell-bearing component of a picowell-bearing device is often a chip, a plate or other substantially planar component. Herein such a component is termed a "carrier". In the art, there also exist non-carrier picowell-bearing components of picowell-bearing devices, for example, bundles of fibers or bundles of tubes.

Mrksich and Whitesides, *Ann. Rev. Biophys. Biomol. Struct.* 1996, 25, 55-78; Craighead *et al.*, *J. Vac. Sd. Technol* 1982, 20, 316; Singhvi *et al.*, *Science* 1994, 264, 696-698; Aplin and Hughes, *Analyt. Biochem.* 1981, 113, 144-148 and U.S. Patent No. 5,324,591 all teach of devices including arrays of spots of cell-attracting or cell-binding entities on a plate. In such devices, the spots serve as picowells, binding cells through a variety of chemical bonds. In such devices, the plate is the picowell-bearing component of the device. Due to the size of the spots, each such picowell generally holds more than one cell. To reduce interaction between cells held at different picowells, the spots must be spaced relatively far apart, reducing loading as expressed in terms of picowells per unit area. Even with generous spacing, in such picowell-bearing components held cells are not entirely isolated from mutual interaction, nor can cells be subject to individual manipulation. The fact that the cells are not free-floating but are bound to the plate

- 5 -

through some interaction necessarily compromises the results of experiments performed.

In U.S. Patent No. 6,103,479, the picowell-bearing component is a transparent carrier provided with a non-uniform array of picowells, each well functionalized with chemical entities that bind to cells specifically or non-specifically. Each picowell is of approximately 200 to 1000 micron diameter and is configured to hold a plurality of cells. The inter picowell areas are hydrophobic so as not to attract cells. In addition to the carrier, a device of U.S. Patent No. 6,103,479 is provided with a glass, plastic or silicon chamber-bearing plate in which individually addressable microfluidic channels are etched, the chamber-bearing plate configured to mate with the carrier. When mated, the carrier and chamber-bearing plate constitute a cassette in which each cell is bound to the carrier and isolated in a chamber provided with an individual fluid delivery system. Reagents are provided through the fluid delivery system and observed by the detection of fluorescence. In order to provide space for the walls of the chambers, the inter picowell areas of the carrier are relatively large, reducing loading as expressed in terms of picowells per unit area. Subsequent to study, the cassette is separated into the two parts and the micro-patterned array of cells processed further. In some embodiments, the chamber-bearing plate is made of polytetrafluoroethylene, polydimethylsiloxane or an elastomer. As held cells do not make contact with the chamber-bearing plate it is not clear what advantages are to be had when providing a chamber-bearing plate of such esoteric materials.

In U.S. Patent Application No. 10/199,341, a device is taught for trapping a plurality of dielectric objects (such as cells), each individual object in an individual light beam produced by an optical array.

In U.S. Patent No. 4,729,949 of the inventor, a device is taught for trapping individual cells in a picowell-bearing carrier, the carrier being substantially a plate having a plurality of picowells that are individually-addressable tapered apertures of a size to hold individual cells. Suction applied from the bottom surface of the plate where the picowells are narrow creates a force that draws cells suspended in a fluid above the carrier into the wide end of the picowells on the surface of the carrier to be held therein. Using the teachings of U.S. Patent No. 4,729,949 a specific group of cells (having dimensions similar to that of the wide end of the picowells) can be selected from amongst a group of cells and held in the carrier. Although the cells are subjected to

- 6 -

common stimuli, the fact that the picowells are individually addressable allows the effect of a stimulus on an individual cell to be observed. A carrier of U.S. Patent No. 4,729,949, is generally made of metal such as nickel and prepared using standard photoresist and electroplating techniques. In a carrier of U.S. Patent No. 4,729,949, the inter picowell areas of the carrier are relatively large, leading to a low loading as expressed in terms of picowells per unit area. Further, the suction required to hold cells in picowells of a carrier of U.S. Patent No. 4,729,949 deforms held cells and makes a significant portion of the cell membranes unavailable for contact, both factors that potentially compromise experimental results. Study of cells with non-fluorescence based methods generally gives poor results due to reflections of light from the carrier.

In PCT Patent Application No. US99/04473 published as WO 99/45357 is taught a picowell-bearing component produced by etching the ends of a bundle of optical fibers (apparently of glass) while leaving the cladding intact to form a picowell-bearing component that is a bundle of tubes. The size of the hexagonal picowells is demonstrated to be as small as 7 micron wide, 5 micron deep and having a volume of about 1.45×10^{-13} liter. The inter picowell area is quite large due to the thickness of the cladding of the optical fibers. Light emitted by cells held in each picowell are independently observable through a respective optical fiber. In some embodiments, the inside surface of the picowells is coated with a film of materials such as collagen, fibronectin, polylysine, polyethylene glycol, polystyrene, fluorophores, chromophores, dyes or a metal. Loading the picowell-bearing component of PCT Patent Application No. US99/04473 includes dipping the optical fiber bundle in a cell suspension so that cells adhere to the picowells. There are a number of disadvantages to the teachings of PCT Patent Application No. US99/04473. The fact that the cells are studied only subsequent to adhesion to the picowells necessarily influences the results of experiments performed. Since cell proliferation generally begins soon after adhesion, it is not known if a detected signal is produced by a single cell or a plurality of cells. It is not clear where exactly in a picowell a cell is held and therefore what percentage of light emitted from a cell travels to a detector. The fact that emitted light travels through an optical fiber leads to loss of time-dependent and phase information.

In PCT Patent Application No. IL04/00194 published as WO 04/077009 of the Applicant is taught a picowell-bearing component produced by bundling together glass capillaries, each glass capillary attached to an independent fluid flow generator such as

- 7 -

a pump. A cell held in a first picowell is transferred to a second picowell by the simultaneous application of an outwards flow from the first picowell and an inwards flow into the second picowell.

A preferred device for the study of cells is described in PCT Patent Application
5 No. ILO 1/00992 published as WO 03/035824 of the Applicant. The device 10, depicted
in Figure 1, is provided with a transparent carrier 12 as a picowell-bearing component.
Carrier 12 is substantially a sheet of transparent material (such as glass or polystyrene)
on the surface of which features such as inlet connectors 14, fluid channels 16,
picowells (in Figure 1, a picowell-array 18), a fluid reservoir 20 and an outlet connector
10 22. Carrier 12 is immovably held in a holder 24 having a cutout window of a size and
shape to accept carrier 12. Other components of device 10 not depicted include flow
generators, observation components, external tubing and the like. When a cover slip
(not depicted) is placed or integrally formed with carrier 12, fluid channels 16,
picowell-array 18 and reservoir 20 are sealed forming channels that allow transport of
15 fluids and reagents to cells held in picowell-array 18. The picowells are configured to
hold a predetermined number of cells (one or more) of a certain size and are preferably
individually addressable both for examination and manipulation.

Figure 2 is a reproduction of a photograph of a different carrier 26 held in a
holder 24. A first syringe 28 as an inlet flow generator is in communication with an inlet
20 connector 14 by a capillary tube 30. Inlet connector 14 is in communication with
picowell-array 18 through a fluid passage 16. Picowell-array 18 is in communication
with outlet connector 22 through a fluid passage 16. A second syringe 32 as an outlet
flow generator is in communication with outlet connector 22 through capillary tube 34.

PCT Patent Application No.ILO1/00992 also teaches methods of physically
25 manipulating cells held in a picowell-bearing device using, for example, individually
addressable microelectrodes (found in the picowells or in the cover slip) or optical
tweezers. Typical physical manipulations include moving selected cells into or out of
specific picowells. One useful method that is implemented using a device of PCT Patent
Application No.IL01/00992 is that cells, each held alone in a respective picowell, are
30 examined (either in the presence or absence of reagents) and based on the results of the
examination, cells with a certain characteristic are selected to remain in a respective
picowell while cells without the certain characteristic are removed from a respective

- 8 -

picowell and ejected by the application of a flow in parallel to the surface of the carrier, generated by a flow generator.

An additional feature of the teachings of PCT Patent Application No. ILO1/00992 is that, in some embodiments, the picowells are juxtaposed, that is, the area occupied by a picowell-array is substantially entirely made up of picowells with little or no inter picowell area, see Figure 3. Figure 3 is a reproduction of a photograph of part of a picowell-array 18 from the top of a carrier 12 of PCT Patent Application No. ILO1/00992. In Figure 3 is seen a plurality of hexagonal picowells 36, some populated with living cells 38. It is seen that the inter picowell areas 40 make up only a minor percentage of the total area of picowell-array 18. This feature allows near tissue-density packing of cells, especially in single-cell picowell configurations. For example, a typical device of PCT Patent Application No. having a 2 mm by 2 mm picowell-array of hexagonally-packed juxtaposed picowells of 10 micron diameter and no inter picowell area includes about 61600 picowells. This feature also allows simple picowell loading: a fluid containing suspended cells is introduced in the volume above the picowells. Since there is little inter picowell area, cells settle in the picowells.

One of the challenges of well-bearing devices known in the art for the study of single living cells, especially picowell-bearing devices, is of information acquisition.

One type of information acquisition is manual image analysis. Manual image analysis involves a cell biology expert visually inspecting cells, for example using an observation component equipped with optical magnification means such as a microscope and drawing conclusions based on the visual inspection. Manual image analysis is time-consuming, incompatible with high-throughput studies and is not generally applicable.

Two other type of information acquisition are automatic image analysis and automatic signal acquisition.

In automatic image analysis, high-resolution optical data is acquired substantially continuously for all wells of interest and cells held therein. A disadvantage of using automatic image analysis is that there is no easy way to sift through the massive amount of information acquired to identify important events from amongst all the images acquired.

In automatic signal analysis, one or limited number of signal channels, usually corresponding to a light intensity, are acquired as a function of time for each well and

- 9 -

cells held therein substantially continuously. Often, the signal channels acquired correspond to different wavelengths of light emitted by fluorescence processes occurring in the wells.

One of the greatest challenges in both automatic image analysis and automatic
5 signal analysis is the delineation of the borders of a single cell. For example, in Figure 4 is depicted a reproduction of a transparent light image of MALT-4 cells on a glass plate. Individual cells and borders thereof were automatically determined. In many cases, cells are not identified. For example, in the upper left corner of Figure 4, an aggregate of three cells designated "159" is identified to be one cell. In the middle right side of
10 Figure 4, the borders of cells designated as "439" and "438" are improperly delineated. In both such cases, analysis of an image or of a signal gives completely wrong results. Even when cells are held in picowells 36, for example, as depicted in Figure 3, it is difficult to delineate the borders of wells and of cells held therein, especially when slight shifting of the picowell-bearing component relative to the field of view occurs,
15 whether due to physical motion of the picowell-bearing component or as a result of motion of the observation component. Further, due to the fact that the material from which wells are made is not invisible, distortions, reflections, diffractions and the image of the picowell walls often make delineation of cells difficult. For example, differentiating cell 42 from cell 44 in Figure 3 is a difficult task. It is important to note
20 that even the imperfect methods known in the art are time consuming, expensive in terms of calculation resources, not robust and in general unsuited for high-throughput applications.

The problem of delineating the borders of a cell for automatic signal analysis is even greater. When automatic signal analysis is implemented, it is desired that the
25 implementation be quick, robust and is directed for high-throughput analysis of many cells. In such applications, it is not practical to have a time consuming cell-identification or picowell-identification step. In addition, if the borders of the cell or picowells are not clearly delineated, the quality of the data is seriously compromised. For example, when a cell is delineated conservatively, and only a portion of a signal emitted by a cell is
30 acquired the values of the acquired signal will be inaccurate, especially in cases where signals are not emitted from all areas of a cell homogeneously. For example, when a cell is delineated too broadly and signals from neighboring cells are also acquired the signal to noise ratio decreases. An additional problem arises when what is to be detected is not

- 10 -

light emitted by a cell itself but rather light emitted by chromatogenic or fluorogenic entities in the medium in the immediate area of the cell, for example the medium held together with the cell in the same picowell. In such experiments it is critical to know the exact borders of the picowell in which a cells is held.

5 In the art, a number of solutions based on providing each well with a dedicated observation system have been proposed.

 As discussed above in PCT patent application US99/04473 is taught a picowell-bearing component produced by etching the ends of a bundle of optical fibers to form a picowell-bearing component where a cell held inside such a picowell necessarily is associated with an adressable optical fiber that tranports light emitted from the picowell
10 to a detector for signal acquisition. As stated above, amongst other problems associated with the device of PCT patent application US99/04473, the fact that the emitted light travels through an optical fiber leads to loss of time dependent and phase information. Further, the device of PCT patent application US99/04473 is not suitable for acquiring
15 high-resolution images.

 A preferred method of automatic image acquisition where a well and the contents thereof are clearly delineated is described, for example, in PCT patent application IL01/000992 where in one embodiment is taught a device having an individual microlens dedicated to the continuous observation of every picowell of the
20 picowell-bearing component and cells held therein. Such a method requires a highly expensive observation system, including a dedicated, accurately crafted and expensive microlens array. Further, such a microlens array must be located above the picowell array and is generally exposed to the medium in which cells are held.

 It would be highly advantageous to have a device and methods for the study of
25 cells not having at least some of the disadvantages of the prior art.

SUMMARY OF THE INVENTION

 The present invention successfully addresses at least some of the shortcomings of the prior art by providing a method for identifying the image of a well in an image of
30 a well-bearing component as well as of a device for implementing the method of the present invention. Embodiments of the present invention also provide for the quick, accurate and robust delineation of the borders of the images of the well.

- 11 -

The present invention uses the optical properties of a well-bearing component to identify the images of respective wells of a well-bearing component. Some or all embodiments of the present invention have advantages including applicability to occupied and unoccupied wells, delineation of images of signal-less occupied wells, allow the use of observation components such as CCD devices as multi-signal detectors, allows delineation of a well image irrespective of the well-bearing component orientation and allows the observation component to be located above or below the well-bearing component.

10 In one aspect of the present invention embodiment, the optical wave-guiding properties of a well-bearing component are used to identify the images of wells.

In another aspect of the present invention, the optical properties of well-walls are used to identify the images of respective wells of a well-bearing component.

15 In another aspect of the present invention, described in particular detail herein, the optical properties of well-bottoms are used to identify the images of respective wells of a well-bearing component.

In another aspect of the present invention, well-bottoms of a well-bearing component are configured to focus light emitted from within a well

20 Further, according to the teachings of the present invention there is provided a method of identifying an image of a well in an image of a well-bearing component, the well-bearing component having a lower surface, an upper surface and a side, the well disposed on the upper surface comprising: passing light through the well-bearing component so that a portion of the light is refracted during the passage through the well-bearing component; and acquiring an image of the refracted light, preferably of refracted light exiting from the upper surface or lower surface of the well-bearing component. In an embodiment of the present invention, based on the acquired image of the refracted light, an area in an acquired image of the well-bearing component is identified, the area to be considered as part of the image of the well. In an embodiment of the present invention, based on the acquired image of the refracted light, a reference point for identifying an area in an acquired image of the well-bearing component is determined, the area to be considered as part of the image of the well.

30 In an embodiment of the present invention, the light passing through the well-bearing component enters the well-bearing component through the side of the well-bearing component. In an embodiment the light is reflected at least once within the

- 12 -

well-bearing component before being refracted, *e.g.* from a surface of the well-bearing component or from an internal feature such as a bubble, particle, occlusion body or other imperfection within the well-bearing component.

5 In an embodiment of the present invention, the light passing through the well-bearing component enters the well-bearing component through a surface (*i.e.*, the upper surface or the lower surface) of the well-bearing component.

10 In an embodiment of the present invention, the refracted light acquired is refracted by features on the lower surface of the well-bearing component. In an embodiment of the present invention, the refracted light acquired is refracted by features on the upper surface of the well-bearing component.

In an embodiment of the present invention, the features refracting the light correspond to the bottom of the well, walls of the well or the intersection of the well with other wells.

15 In an embodiment of the present invention, the light passing through the well-bearing component is of limited wavelength, *e.g.* substantially monochromatic or having a specific color.

20 According to the teachings of the present invention there is also provided a method of identifying an image of a well in an image of at least part of a well-bearing component comprising: illuminating the well-bearing component with a locating light source disposed on a first side of the well-bearing component; and acquiring an image of a focal point (real or imaginary) of a feature of the well-bearing component produced by light from the locating light source passing through the feature.

25 In an embodiment of the present invention, the feature is a border of the well, such as a well-wall or an intersection of the well with another well. In an embodiment of the present invention the feature is a bottom of the well.

30 In an embodiment of the present invention, based on the image of the focal point, an area in an acquired image of the well-bearing component is identified, the area to be considered as part of the image of the well. In an embodiment of the present invention, based on the image of the focal point, a reference point for identifying an area in an acquired image of the well-bearing component is determined, the area to be considered as being part of the image of the well. Preferably the area is delineated based on the reference point.

- 13 -

In an embodiment of the present invention, an image of the well-bearing component is acquired, preferably while the well-bearing component is illuminated with an observation light source. According to a feature of the present invention, an observation component for acquiring the image of the well-bearing component is provided and the focus of the observation component is adjusted so as to acquire an image of the well-bearing component or of the contents of wells, such as cells held in wells.

In an embodiment of the present invention, based on the image of the focal point, a reference point for identifying an area in the acquired image of the well-bearing component is determined, the area defined as part of the image of the well.

According to a feature of the present invention, based on the reference point, borders of the area defined as part of the image of the well are delineated.

According to a feature of the present invention, an observation component for acquiring the image is provided, the observation component including an array of light-responsive elements; and designating the output of a group of light-responsive elements corresponding to the delineated area as corresponding to the image of the well.

In an embodiment of the present invention signals making up the area are summed so as to produce a limited number of signals characterizing the well.

In an embodiment of the present invention, the image of the well-bearing component acquired is pixelated and the summing of signals is substantially summing pixels making up the area. In an embodiment of the present invention, an observation component for acquiring the image is provided, the observation component including an array of light-responsive elements; and the summing up of the pixels is substantially summing up output signals from the light-responsive elements. According to a feature of the present invention, the signals have an intensity, the intensity being related to an intensity of light arriving from a part of the well. According to a feature of the present invention, the signals have an intensity, the intensity being related to an intensity of a component frequency of light arriving from a part of the well.

In an embodiment of the present invention, an observation component for acquiring the image of the focal point is provided, and the focus of the observation component is adjusted so as to acquire an image of the focal point. In an embodiment of the present invention the feature is a bottom of the well and adjusting the focus of the light-detection component is so that the image of the focal point of the bottom of the

- 14 -

well is distinct from an image of a focal point produced by light passing through a bottom of a second well of the well-bearing component.

In an embodiment of the present invention the feature is a bottom of the well and adjusting the focus of the light-detection component is so that the size of the image of the focal point of the bottom of the well is substantially a minimum. In an embodiment
5 of the present invention the feature is a bottom of the well and the reference point is defined as being the image of the focal point. In an embodiment of the present invention the feature is a bottom of the well and the reference point is defined as being the center of the image of the focal point. In an embodiment of the present invention the feature is
10 a bottom of the well and an area defined as part of the image of the well is delineated as a circle about the reference point.

According to the teachings of the present invention, there is also provided a method for acquiring data comprising: a) providing a substantially planar well-bearing component having a lower surface, an upper surface, and a plurality of wells having
15 refractive features disposed on the upper surface and an observation component configured to observe a first of the two surfaces; b) projecting light through the features from a second of the two surfaces; c) acquiring an image of a focal point (imaginary or real) of a feature using the observation component; d) acquiring at least one image of the well-bearing component using the observation component; and e) using the image of
20 the focal point of the feature to determine a reference point for identifying an image of a respective well in the image of the well-bearing component.

In an embodiment of the present invention, the feature is a border of the wells, such as a well-walls or intersections of the wells.

In an embodiment of the present invention the features are the bottoms of the
25 well.

Preferably, when the features are well-bottoms the well-bottoms have a C_{ω} rotation axis. Preferably, the C_{ω} rotation axis is substantially perpendicular to the focal plane of the observation component. Preferably, the light projected is substantially parallel to the rotation axis. Preferably, the light projected is collimated.

In an embodiment of the present invention, the first of the two surfaces is the
30 lower surface and the second of the two surface is the upper surface. In an embodiment of the present invention, the first of the two surfaces is the upper surface and the second of the two surface is the lower surface.

- 15 -

In an embodiment of the present invention, prior to acquiring the image of the focal point, the focus of the observation component is adjusted. Preferably, when the features are well-bottoms the focus is adjusted to an extent where two images of two focal points produced by two well-bottoms are distinct. In an embodiment of the present invention, the focus is adjusted to an extent where the size of the image of the focal point is substantially minimal.

In an embodiment of the present invention, acquiring at least one image of the well-bearing component includes detecting light emitted by fluorescence.

In an embodiment of the present invention, acquiring at least one image of the well-bearing component includes detecting light reflected from the first of the two surfaces.

In an embodiment of the present invention, prior to acquiring at least one image of the well-bearing component, the focus of the observation component is adjusted to focus on contents of the wells.

In an embodiment of the present invention, prior to acquiring at least one image of the well-bearing component, the focus of the observation component is adjusted to focus on the wells.

In an embodiment of the present invention, the reference point is used to delineate a border of the image of the respective well in the image of the well-bearing component. In an embodiment of the present invention, the border delineated is substantially a circle about the reference point.

In an embodiment of the present invention, the reference point is the image of the focal point.

In an embodiment of the present invention, when the features are bottoms of the wells and the reference point is the center of the image of the focal point.

In an embodiment of the present invention, (c) (acquiring an image of the focal point of a feature) precedes (d) (acquiring at least one image of the well-bearing component).

In an embodiment of the present invention (d) (acquiring at least one image of the well-bearing component) precedes (e) (using the image of the focal point of the feature to determine a reference point for identifying an image of a respective well in the image of the well-bearing component).

- 16 -

In an embodiment of the present invention, during step (d), a plurality of time-dependent images of the well-bearing components are acquired.

In an embodiment of the present invention, (c) (acquiring an image of a focal point (imaginary or real) of a feature) is performed during (d) (acquiring at least one
5 image of the well-bearing component). In an embodiment of the present invention, (c) is performed more than once during (d).

In an embodiment of the present invention, the image of the well-bearing component is pixelated.

In an embodiment of the present invention, a group of pixels is designated as
10 corresponding to the image of a respective well, based on the reference point. In an embodiment of the present invention, values related to the group of pixels are summed so as to yield a signal characteristic of the respective well. In an embodiment of the present invention, the values are related to an intensity of light acquired by the observation component from a part of the respective well. In an embodiment of the
15 present invention, the values are related to an intensity of component frequencies of light acquired by the observation component from a part of the respective well.

In an embodiment of the present invention, at least one image of the well-bearing component is stored, preferably as digital data. In an embodiment of the present invention, prior to storing, the amount of digital data stored is reduced by removing
20 and/or discarding data not corresponding to images of the wells.

According to the teachings of the present invention there is also provided a method for the study of cells, comprising: a) providing a well-bearing component having a lower surface, an upper surface and a plurality of wells disposed on the upper surface, the wells configured to hold at least one living cell wherein bottoms of the
25 wells are configured to focus light emitted from within a well and passing through a respective well bottom; b) holding a liquid (*e.g.*, water, saline and physiological medium) in the wells; and c) detecting light emitted from within a well and passing through a respective well bottom. In an embodiment of the present invention the light emitted from within a well is a result of a cell held within the well, *e.g.*, a cell emits
30 light or releases a material that causes an indicator to emit light from within the well. In an embodiment of the present invention, the configuration to focus light includes that the bottoms of the wells are fashioned of a material having an index of refraction lower than that of the liquid held in the wells.

- 17 -

According to the teachings of the present invention, there is also provided a device for the study of cells comprising: a) a well-bearing component having a lower surface, an upper surface and a side; b) a plurality of wells disposed on the upper surface; and c) a light source configured to illuminate the well-bearing component through the side. In an embodiment of the present invention, the well-bearing component is configured to act as a wave-guide for light produced by the light source. In an embodiment of the present invention, the light source is configured to produce visible light of in a limited range of wavelengths, *e.g.*, substantially monochromatic light.

10 According to the teachings of the present invention there is also provided a device for the study of cells comprising: a) a well-bearing component having a lower surface and an upper surface; and b) a plurality of wells disposed on the upper surface, the wells configured to hold at least one living cell, characterized in that the wells have well-bottoms configured to focus light emitted from within a well and passing through a respective well bottom, for example, by providing well-bottoms having a low index of refraction, *e.g.*, an index of refraction lower than that of water.

20 According to the teachings of the present invention there is also provided a device for the study of cells comprising: a) a well-bearing component having a lower surface and an upper surface; b) a plurality of wells disposed on the upper surface, the wells configured to hold at least one living cell, and c) a liquid (*e.g.*, water, saline and physiological medium) held in the wells characterized in that the wells have well-bottoms fashioned of a material having an index of refraction lower than that of the liquid.

25 In an embodiment, a device of the present invention is provided with d) a substantially planar light detector functionally associated with the lower surface, either directly or with an intervening spacer positioned between the lower surface and the light detector.

30 It is important to note that although the singular term "material" is used, the intent is that a well-bottom is made of a material or a combination of materials such that the index of refraction of the well-bottom is as desired.

The index of refraction of materials having an index of refraction that is dependent on temperature, is that measured at physiological temperatures (*i.e.*, between 0 °C and 50 °C, and especially about 40 °C).

- 18 -

In an embodiment of the present invention, the index of refraction of the material from which the well bottom fashioned is less than 1.33.

In an embodiment of the present invention, the well-bearing component essentially consists or consists of the material. In an embodiment of the present invention the material is polytetrafluoroethylene.

In an embodiment of the present invention, the bottom surface of the wells is concave.

In an embodiment of the present invention the wells are juxtaposed. In an embodiment of the present invention the interwell area between two wells is less than about 0.35, less than about 0.25, less than about 0.15, less than about 0.10 and even less than about 0.06 the sum of the areas of the two wells. In an embodiment of the present invention the rim of a well is substantially knife-edged.

As the present invention is directed to the study of cells, the dimensions of the wells are typically less than about 200 microns, are less than about 100 microns, less than about 50 microns, less than about 25 microns and even less than about 10 microns.

Embodiments of the present invention include wells configured to hold no more than one living cell of a certain type at any one time or to hold a predetermined number of living cells of a certain type at any one time.

In an embodiment of the present invention, the wells are enclosures of dimensions such that substantially an entire cell of a certain type is containable within an enclosure, each enclosure having an opening at the upper surface, the opening defined by a first cross section of a size allowing passage of a cell of a certain type. Depending on the embodiment, the volume of such an enclosure is typically less than about 1×10^{-11} liter, less than about 1×10^{-12} liter, less than about 1×10^{-13} liter, less than about 1×10^{-14} liter or even less than about 1×10^{-15} liter. Depending on the embodiment, the area of the first cross section of such an enclosure is typically less than about 40000 micron², less than about 10000 micron², less than about 2500 micron², less than about 625 micron² or even less than about 100 micron², in an embodiment of the present invention the area of a first cross section is less than about 40000 micron², less than about 10000 micron², less than about 2500 micron², less than about 625 micron², and less than about 100 micron². In an embodiment of the present invention the dimensions of an enclosure are such as to contain no more than one cell of a certain size at any one time.

- 19 -

Unless otherwise defined, all technical and scientific terms used herein have the same meaning as commonly understood by one of ordinary skill in the art to which this invention belongs. Although methods and materials similar or equivalent to those described herein can be used in the practice or testing of the present invention, suitable methods and materials are described below. In case of conflict, the patent specification, including definitions, will control. In addition, the materials, methods, and examples are illustrative only and not intended to be limiting.

BRIEF DESCRIPTION OF THE DRAWINGS

10 The invention is herein described, by way of example only, with reference to the accompanying drawings. With specific reference now to the drawings in detail, it is stressed that the particulars shown are by way of example and for purposes of illustrative discussion of the preferred embodiments of the present invention only, and are presented in the cause of providing what is believed to be the most useful and readily understood description of the principles and conceptual aspects of the invention. In this regard, no attempt is made to show structural details of the invention in more detail than is necessary for a fundamental understanding of the invention, the description taken with the drawings making apparent to those skilled in the art how the several forms of the invention may be embodied in practice.

20 In the drawings:

FIG. 1 (prior art) depicts a cell-chip device of PCT patent application ILO 1/00992 including a transparent carrier;

FIG. 2 (prior art) is a reproduction of a photograph of a cell-chip device of PCT patent application ILO 1/00992;

25 FIG. 3 (prior art) is a reproduction of a photograph of a cell-populated well-array of a carrier of a cell-chip device of PCT patent application IL01/00992;

FIG. 4 (prior art) is an image of MALT-4 cells on a glass plate where the borders of the cells are delineated by prior art image processing methods;

30 FIGS. 5A and 5B are flow charts of embodiments of the method of the present invention;

FIGS. 6A and 6B are schematic depictions of an embodiment of a device of the present invention useful in implementing the method of the present invention;

- 20 -

FIG. 7 is a reproduction of a scanning electron micrograph of an array of wells of a well-bearing component;

FIG. 8 is a reproduction of a scanning electron micrograph of a template used for producing an array of wells of a well-bearing component;

5 FIG. 9 is a depiction of the refractive properties of typical plano-concave well-bottoms;

FIGS. 10A-10E are depictions of an array of pixels visually representing an image as stored by an image processing component;

10 FIGS. HA and HB are reproductions of images of focal points of well-bottoms of a well-bearing component acquired in accordance with the teachings of the present invention;

FIG. 11C is a reproduction of an image of a well-bearing component of Figures 11A and 11B acquired while focusing on the individual wells;

15 FIG. 12 is a reproduction of an image of a well-bearing component where images of individual wells are identified and delineated in accordance with the teachings of the present invention;

FIGS. 13A and 13B are reproductions of images of a well-bearing component holding MALT-4 cells, where images of individual wells are identified and delineated in accordance with the teachings of the present invention;

20 FIGS. 14A and 14B are reproductions of images of a well-bearing component holding MALT-4 cells, where images of cells held in individual wells are identified and delineated whereas images of inter-well areas are discarded in accordance with the teachings of the present invention;

25 FIGS. 15A-15H is a depiction of the refractive properties of typical well-bottoms;

FIG. 16 is a schematic depiction of a well-bearing component with wells having well bottoms with a C_2 rotation axis;

FIG. 17 is a schematic depiction of an embodiment of a device of the present invention useful in implementing the method of the present invention;

30 FIG. 18 is a depiction of the refractive properties of a typical well-wall;

FIG. 19 is a schematic depiction of the wave-guide properties of a well-bearing component of the present invention; and

- 21 -

FIG. 20 is a schematic depiction of an embodiment of a device of the present invention having well bottoms configured to focus light emitted from cells held within respective wells.

5 DESCRIPTION OF EMBODIMENTS OF THE INVENTION

The present invention is of a method for identifying an image of a well in an image of a well-bearing component, for example in the field of biology during optical study of cells. The present invention is also of a device useful in implementing the method of the present invention.

10 The principles, uses and implementations of the teachings of the present invention may be better understood with reference to the accompanying description and figures. Upon perusal of the description and figures present herein, one skilled in the art is able to implement the teachings of the present invention without undue effort or experimentation. In the figures, like reference numerals refer to like parts throughout.

15 Before explaining at least one embodiment of the invention in detail, it is to be understood that the invention is not limited in its application to the details set forth herein. The invention can be implemented with other embodiments and can be practiced or carried out in various ways. It is also understood that the phraseology and terminology employed herein is for descriptive purpose and should not be regarded as
20 limiting.

Generally, the nomenclature used herein and the laboratory procedures utilized in the present invention include techniques from the fields of biology, chemistry and engineering. Such techniques are thoroughly explained in the literature. Unless
25 otherwise defined, all technical and scientific terms used herein have the same meaning as commonly understood by one of ordinary skill in the art to which the invention belongs. In addition, the descriptions, materials, methods and examples are illustrative only and not intended to be limiting. Methods and materials similar or equivalent to those described herein can be used in the practice or testing of the present invention. AU
30 publications, patent applications, patents and other references mentioned are incorporated by reference in their entirety as if fully set forth herein. In case of conflict, the specification herein, including definitions, will control.

As used herein, the terms "comprising" and "including" or grammatical variants thereof are to be taken as specifying the stated features, integers, steps or components

- 22 -

but do not preclude the addition of one or more additional features, integers, steps, components or groups thereof. This term encompasses the terms "consisting of and "consisting essentially of.

The phrase "consisting essentially of" or grammatical variants thereof when used
5 herein are to be taken as specifying the stated features, integers, steps or components but do not preclude the addition of one or more additional features, integers, steps, components or groups thereof but only if the additional features, integers, steps, components or groups thereof do not materially alter the basic and novel characteristics of the claimed composition, device or method.

10 The term "method" refers to manners, means, techniques and procedures for accomplishing a given task including, but not limited to, those manners, means, techniques and procedures either known to, or readily developed from known manners, means, techniques and procedures by practitioners of the chemical, pharmacological, biological, biochemical and medical arts. Implementation of the methods of the present
15 invention involves performing or completing selected tasks or steps manually, automatically, or a combination thereof.

Herein, the term "active entity" is understood to include chemical, biological or pharmaceutical entities including any natural or synthetic chemical or biological
20 substance that influences a cell with which the entity interacts. Typical active entities include but are not limited to active pharmaceutical ingredients, antibodies, antigens, biological materials, chemical materials, chromatogenic compounds, drugs, enzymes, fluorescent probes, immunogenes, indicators, ligands, nucleic acids, nutrients, peptides, physiological media, proteins, receptors, selective toxins and toxins.

Herein, by "indicator" is meant any active entity that upon interaction with some
25 stimulus produces an observable effect. In the context of the present invention, by stimulus is meant, for example, a specific second active entity (such as a molecule) released by a cell and by observable effect is meant, for example, a visible effect, for example a change in color or emission of light, for example by fluorescence.

Herein, by "pixelation" is meant the process by which an image is divided into
30 many discrete elements (pixels), the pixels together constituting the image. By pixelation is also meant the process that occurs when an image is projected onto a pixelated detector, such as a CCD or CMOS detector array so that each part of the

- 23 -

image is detected by a different discrete light-responsive element, so that the output of each light-responsive element is a pixel.

Embodiments of the present invention include components that are transparent or are made of a transparent material. By "transparent" is meant that the component or material is substantially transparent to radiation having a wavelength in at least part of the visible light spectrum, the ultraviolet light spectrum and/or of infrared radiation.

The method of the present invention is useful in the study of living cells. As is discussed in the introduction, it is known to study cells held, individually or in groups, in wells of a well-bearing component such as a multi-well plate or a cell-chip carrier (such as discussed in PCT Patent Application ILO 1/00992). In the art it is common to focus an observation component on the cells or the well and acquire images, whether non-time dependent images or signals (stills) or as a series of images so as to acquire time-dependent images or signals. Subsequently, the acquired images are pixelated and the borders of the individual wells delineated by image-analysis techniques. Existing image-analysis techniques require large amounts of resources and give insufficient results, often failing to differentiate between two wells.

The present invention is a method for identifying an image of a well in an image of a well-bearing component. Once an image of a well is identified, the present invention allows delineation of the borders of the image of the well. For pixelated images, the method of the present invention allows designation of specific pixels as being components of the image of a specific well. As is discussed hereinbelow in detail, such a designation of pixels allows for the use of an observation component, such as a CCD camera, as a high-speed multi-channel detector useful in high-throughput screening methods whilst retaining high-resolution optical data.

Implementation of the present invention is dependent on using an observation component to observe a well-bearing component where features of the walls, such as the bottoms of the wells, have optical properties. One aspect of the present invention includes approaching focus, of a real focal point or of an imaginary focal point of the well-bottom so as to acquire an image of light passing through a feature such as a well-bottom that is preferably smaller than and preferably included within the image of the well when focusing on the well. The image of the focal point of the feature is then used to determine a reference point to identify the image of the well in the image of the well-bearing component and from which to delineate the borders of the well.

- 24 -

In a preferred embodiment of the present invention, the feature used is the bottom of the well. Preferably the bottom of the well has a C_{00} rotation axis. Preferably, the C_{00} rotation axis is substantially perpendicular to the focal plane of the observation component and the observation component is configured to acquire the image of the focal point substantially perpendicularly to the upper surface of the well-bearing component so that the image of the focal point is centered about the center of the image of the well. In a preferred embodiment, the observation component is focused on the real or imaginary focal point of the well bottom so that the image of the focal point is substantially a point of light substantially located in the center of the image of the well.

5

10 In a preferred embodiment, the borders of the well are delineated as defining a circle of a certain radius about the image of the focal point. In a preferred embodiment, the pixels found within the circle of the certain radius are designated as being components of the image of the well.

The method of the present invention allows for quick, accurate and robust delineation of the borders of a well. Some or all embodiments of the present invention have many advantages including:

15

- identification of wells whether occupied or unoccupied by cells;
- delineation of signal-less wells ;
- use of pixelating observation components (*e.g.*, CCD or CMOS detectors) as

20 multi-channel detectors;

- delineation irrespective of well-bearing component orientation; and
- allowing the observation component to be positioned above or below the well-bearing component.

The method of the present invention is a part of a process for gathering optical data for the study of cells held in well-bearing components. Although the method of the present invention is described herein for the study of cells held in a picowell-bearing microchip carrier such as discussed in PCT patent application ILO1/00992 where each picowell holds one or other small number of cells, the teachings of the present invention are also applicable for the study of cells held in wells larger than picowells such as nanowells or microwells, as found in well-known and commercially available well-bearing components such as multiwell plates having 6, 12, 48, 96, 384 or 1536 wells.

25

30

It is assumed that the method of the present invention is implemented for studying a cell held in a well having a refractive transparent well-bottom, where there is

- 25 -

a light source on one side of the well-bottom and an optical observation component having a variable focus on the other side of the well-bottom. By refractive transparent well-bottom is meant that light passing through the well-bottom is refracted.

The embodiment of the present invention that is currently considered to be the best mode of implementing the method of the present invention is described by the flow charts depicted in Figures 5A and 5B. In Figure 5A are depicted two steps, S2 and S4, of the method of the present invention. In Figure 5B are depicted steps S2 and S4 together with two additional steps S6 and S8 making up the currently known best mode of implementing the teachings of the present invention for actually studying cells.

In step S2, the observation component is used to acquire an image of a real or imaginary focal point of the bottom of the well. In step S4, a reference point from which the the image of the well is identified is determined based on the image of the focal point. In step S6, the borders of the well are delineated by reference to the determined reference point. In step S8, optical data comprising an image of the well-bearing component is acquired. As is discussed hereinbelow, the optical data acquired in step S8 is of any type including high-resolution optical data or signal data.

As is discussed hereinbelow in greater detail, the order of performing the steps as depicted in Figure 5B is not an important feature of the present invention. For example, depending on the embodiment, step S2 is performed before, during or after step S8. It is important to note, however, that in a preferred embodiment of the present invention, step S2 and step S8 are performed so that the images acquired in each step respectively are superimposable. This is most conveniently performed by using the same observation component to perform both step S2 and step S8 without changing the orientation of the well-bearing component relative to the observation component.

A preferred embodiment of the the method of the present invention is described in greater detail with reference to a device 50, schematically depicted in Figures 6A and 6B. In Figure 6A, device 50 is schematically depicted. In Figure 6B, an enlarged view of components found in box 52 are schematically depicted.

Device 50 includes a substantially planar glass well-bearing component 54 having an upper surface 56 and a substantially planar lower surface 58. On upper surface 56 is disposed a plurality of wells 60, wells 60 having a diameter of 20 micron and refractive transparent well-bottoms 62. Some wells 60b hold living cells 64 whereas some wells 60a do not hold living cells.

- 26 -

Well-bearing component 54 is substantially a carrier of a cell-chip device made in accordance with the teachings of PCT patent application ILO1/00992. In Figure 7, a scanning electron micrograph of wells of a well-bearing component 54 is reproduced. Well-bearing component 54 and wells 60 are produced by a process including
5 solidifying molten glass in contact with a nickel template comprising negatives of wells 60 as described in PCT Patent Application ILO1/00992. An electron micrograph of a nickel template used for producing well-bearing component 54 is reproduced in Figure 8. Since the negatives of wells 60 in Figure 8 are hemispheres and since lower surface 58 of well-bearing component 54 is planar, well-bottoms 62 are substantially piano
10 concave lenses having a C_0 rotation axis.

In Figures 6A and 6B, well-bearing component 54 rests upon a transparent support plate 66 and is held firmly in place by holders 68.

Disposed above upper surface 56 of well-bearing component 54 is an observation component 70, in Figure 6 an Olympus BX61 motorized research
15 microscope (Olympus America Inc., Melville, NY, USA). Observation component 70 includes an adjustable focus lens 72 and a detection array 74 of a plurality of light responsive elements 76 (in Figure 6 a CCD array of a DP70 digital camera (Olympus America Inc., Melville, NY, USA)) to convert light impinging on detection array 74 into electronic signals. Adjustable focus lens 72 is functionally associated with a
20 focusing motor 78 controlled by a focus control component 80. The focal plane of observation component 70 is substantially perpendicular to the C_0 rotation axis of well-bottoms 62.

Observation component 70 is functionally associated with an image processing component 82, substantially a computer configured with hardware and software to
25 manipulate electronic signals received from detection array 74 as an image as well as to process the individual pixels of the image as desired. Commercially available software suitable for image processing is, for example, Image Pro Plus (Media Cybernics Inc., Silver Spring, MD, USA).

A control computer 84 is functionally associated with both focus control
30 component 80 and image processing component 82.

A locating light source 86 is disposed below lower surface 58 of well-bearing component 54, that is, the side opposite the side where observation component 70 is disposed. In device 50, locating light source 86 is a light-emitting diode. Locating light

- 27 -

source 86 in Figure 6A is functionally associated with a collimator 88, collimator 88 functioning so that light produced by locating light source 86 passes through well-bottoms 62 substantially parallel to the C_{00} rotation axes of well-bottoms 62.

5 An observation light source 90 is disposed above upper surface 56 of well-bearing component 54, that is, the same side where observation component 70 is disposed. In device 50, observation light source 90 is a light-emitting diode.

In Figure 9, the refractive properties of a well-bottom 62a of a well 60a are depicted. As well-bottom 62a is substantially a symmetrical plano concave lens, light 90 from locating light source 86 passing collimator 88, through and emerging from well-bottom 62a diverges so as to form an imaginary focal point F'.

An embodiment of the method of the present invention implemented using a device 50, and with reference to Figures 5A, 5B, 6A, 6B, 9 and 10 is now discussed.

In step S2, an image of a real or imaginary focal point of the bottom of the well is acquired. Since, in Figures 5A, 5B, 6A, 6B and 9 well-bottoms 62 are divergent lenses, the focal points are imaginary focal points F'.

To acquire an image of the imaginary focal points, locating light source 86 is activated and light impinging on detection array 74, after passing through well-bottoms 62 and adjustable focus lens 72, is converted into an image by image processing component 82. The image is sent to control computer 84. Control computer 84 sends commands to focusing control component 80 to activate focusing motor 78 to adjust the focus of adjustable focus lens 72 while monitoring the changes in the image sent from image processing component 82 resulting therefrom.

25 Unlike prior art methods where an effort is made to adjust adjustable focus lens 72 to focus light from a cell 64 onto detection array 74 and thus acquire a high-resolution image of cell 64, according to the method of the present invention, adjustable focus lens 72 is adjusted to concentrate light 92 diverging from an imaginary focal point F' of a well-bottom 62 of a well 60 onto detection array 74,

In Figures 10A-10E, is depicted a 9 by 20 array 93 of 180 pixels 95 representing a visual representation of an image as stored by image processing component 82. In each one of Figures 10A-10E appear two circles 97 each delineating a group 99 of pixels. Each delineated group 99 of pixels is considered by image processing component 82 to define a respective circle 97.

- 28 -

Images of the imaginary focal points of well-bottoms 62a and 62b as stored by image processing component 82 are depicted in Figure 10A. It is seen that each image is represented by five activated pixels.

It is important to note that the method of the present invention is, unlike prior art methods, equally effective for identifying the images of occupied and empty wells. In Figure 9 are depicted two wells, an empty well 60a and an occupied well 60b holding a cell 64. As discussed above for well 60a, light 92 from locating light source 86 passes through collimator 88, passes through well-bottoms 62a and 62b of wells 60a and 60b, respectively, and diverges. Light 92 is gathered by adjustable focus lens 72. Adjustable focus lens is set to concentrate light 92 from imaginary focal points F' onto detection array 74 forming images of the imaginary focal points. When comparing the images of the respective imaginary focal points F' formed by well-bottoms 62a and 62b, it is important to note that since adjustable focus lens 72 is used to concentrate light 92 diverging from a single imaginary focal point F' for each well-bottom 62a and 62b, cell 64 held in well 60b reduces the intensity of a respective image, but does not change the location of that image on detection array 74. For similar reasons, the location of a cell 64 held within a respective well 60b does not change the relative location of a respective image.

Since the presence of a cell 64 in a well 60b may significantly reduce the intensity of an acquired image of an imaginary focal point of a respective well-bottom 62b, in some embodiments of the present invention it is preferred to focus the light from a focal point of a well-bottom as much as possible so as to ensure that the light impinges on a small an areas as possible (for pixelated detectors, on as few light responsive elements of a respective detection array as possible). In such a way, even when a very large proportion of light passing through a given well-bottom is blocked by a cell held in the respective well, the image of the imaginary focal point of the well-bottom is easily acquired and identified. A schematic depiction of the images of the imaginary focal points of well-bottoms 62a and 62b after focusing all light from each well-bottom on a single light responsive element 76 as stored by image processing component 82 is depicted in Figure 10B. It is seen that each image is represented by only one pixel.

Although it is advantageous to focus all light from a well-bottom on a single pixel, it is undesirable to spend much time focusing during the performance of step S2. Therefore in some embodiments of the present invention, during step S2, adjustable

- 29 -

focus lens 72 is adjusted to a predetermined focus setting that is expected to produce sufficiently intense images of the focal points of the well bottoms. In an alternative embodiment, the setting of adjustable focus lens 72 is varied with continuous monitoring of the intensity of light impinging on light responsive elements 76 of
5 detection array 74 by image processing component 82. When a maximum intensity of light impinging on light responsive elements 76 corresponding to the center of an image of an imaginary focal point of one, some or all well-bottoms 62 is passed, a desired degree of focus is considered to have been achieved.

Once a desired degree of focus is achieved, a pattern of light spots 94 separated
10 by darker areas is produced on detection array 74 by well-bearing component 54, as depicted in Figures 1IA and 1IB, light spots 94 being the images of the imaginary focal points of well-bottoms 62. In Figure 1IA is seen an image acquired after adjustable focus lens 72 is set to a predetermined setting, producing relatively large, diffuse light spots 94. In Figure 1IB is seen an image acquired after an effort is made to focus on the
15 focal points, producing very sharp light spots 94. In Figure 1IC is seen an image acquired after adjustable focus lens is set to focus on wells 30. It is important to note that when Figure 10A, 10B and 10C are superimposed, sharp light spots 94 of Figure 10B are found in the exact center of diffuse light spots 94 of Figure 10A and in the exact center of wells 36 of Figure 11C.

20 From light spots 94 corresponding to images of well-bottoms 62, a reference point for identifying the image of each respective well 60 is determined, step S4, followed by delineation of the borders of the images of the wells, step S6.

In a preferred embodiment of the present invention, both step S4 and step S6 are image processing steps performed by control computer 84, image processing component
25 82 or both. Although one skilled in the art recognizes that image processing is performed by manipulating an electronically stored digital representation of an image, the method of the present invention is described with reference to an image as the accepted and most understandable way of describing image processing processes. A device comprising hardware, software or a combination thereof for electronically
30 storing a digital representation of an image and manipulating the image as required for implementing the method of the present invention is easily provided by one skilled in the art without undue effort or experimentation upon reading the description herein.

- 30 -

In an embodiment of step S4 of the present invention, a light spot 94 (or more accurately, the representation of an image of light spot 94, such as 99 in Figure 10A or Figure 10B) is designated to be a reference point for identifying an image of a respective well 60.

5 In an embodiment of step S4 of the present invention, a reference point for identifying an image of a well 60 is designated as a group 99 of one or more pixels constituting a respective light spot 94. In a preferred embodiment, the pixel or pixels constituting the center of group 99 are designated to be a reference point for identifying the image of a respective well 60. The identification of a pixel or pixels constituting the
10 center of a group of pixels 99 is well-known to one skilled in the art.

Once a reference point for each image of each desired well 60 is designated, the borders of each image of each well 60 are delineated, step S6. It is important to note that what is meant by delineating the borders of an image of a well 60 is that the portion of an acquired image of a well-bearing component 54 that corresponds to the image of well
15 60 is determined. When the image of a well-bearing component 54 is pixelated, what is meant is that the pixels that constitute the image of well 60 are determined.

It is a simple matter for one skilled in the art to delineate an area of an image or to designate pixels as belonging to a certain group of pixels in relationship to a reference point, once the reference point has been determined. Discussed herein in detail
20 is a preferred embodiment of step S6 of the present invention, where the images of the focal points are pixelated and the reference point for any given well is the group of pixels 99 corresponding to light spot 94 (*e.g.*, groups 99a and 99b in Figure 10A) or the pixels at the center of group 99 (*e.g.*, groups 99a and 99b in Figure 10B).

In a first step, for each well 60, a respective reference point is designated to be
25 the group of pixels 99 constituting a substantially circular, central part of a respective focal point image, *e.g.*, groups 99a and 99b in Figure 10A or 10B.

In a second step, for each well 60, the radius of the substantially circular group of pixels 99 that is a reference point is increased. The second step is repeated until any two substantially circular reference points of two neighboring wells are separated by a
30 certain predetermined distance, for example one, two, three or more pixels.

In an embodiment of the present invention, the second step of increasing the radii of the reference points is performed incrementally, for example by one pixel per cycle. Such an incremental process is graphically depicted by the changes from Figure

- 31 -

10A (or Figure 10B) to Figure 10C, Figure 10C to Figure 10D and Figure 10D to Figure 10E. In Figure 10E, group 99a and group 99b are separated by one pixel.

In another embodiment of the present invention, the second step of increasing the radii of the reference points is performed in one step by calculating the appropriate radii from the coordinates of the reference points. Such a process is graphically depicted
5 by the changes from Figure 10A (or Figure 10B) to Figure 10E.

Since, in a preferred embodiment, well-bottom 62 of a well 60 has a C_{∞} rotation axis perpendicular to the focal plane of observation component 70 the image of the imaginary focal point F' of well-bottom 62 is located in the center of an eventually
10 acquired image of well 60. In other words, if adjustable focus lens 72 is adjusted so as to focus on features of well 60 or of a cell 64 held in well 60, the light reflected from the center of well 60 impinges on the same light responsive elements 76 of detection array 74 as light 92 diverging from the imaginary focal point F' .

The result of step S4 is the establishment of a reference point from which to
15 identify a part of an image of a well-bearing component 54 corresponding to an individual well 60. The result of step S6 is the delineation of an area of an image of well-bearing component 54 corresponding to an individual well 60. In embodiments of the present invention, the results of step S4 and S6 are used by image processing component 82 and control computer 84, for example, to identify the location of a well
20 60 and, if desired, to focus onto that well 60. In preferred embodiments of the present invention, the results of step S4 and S6 are used by image processing component 82 and control computer 84 to analyze and output only selected data from all acquired data. The selected data analyzed or output is that corresponding to wells 60 or to specific wells 60 having certain characteristics.

25 Thus, subsequent to step S4 and S6, if it is desired to study only an image of a single well 60, image processing component 82 and control computer 84 analyze and display only areas corresponding to that single well 60. For a pixelated image only pixels corresponding to wells 60 are analyzed and displayed. For example, in Figure 10E, pixels of an image of a well-bearing component 54 belonging to a group 99a are
30 considered to make up an image of an individual cell and are analyzed and displayed as such.

- 32 -

Hereinbelow, step S8 will be described with reference to device 50 and as if step S8 is performed subsequently to step S2, step S4 and step S6. The description of the steps in such an order is considered to be the simplest to understand.

5 In step S8, the desired optical data is acquired as an image of well-bearing component 54, preferably using observation component 70. In an embodiment of the present invention, the optical data gathered is time-dependent. In an embodiment of the present invention, the optical data gathered is not time-dependent.

10 Generally, but not necessarily, locating light source 86 is deactivated. According to embodiments of the present invention, for example when it is desired to observe light reflected from cells 64 held in wells 60 or to acquire high-resolution optical data, observation light source 90 is activated. In other embodiments of the present invention, for example when the optical data gathered is light emitted by fluorescence of cells 64 or active ingredients such as indicators, observation light source 90 is not necessarily activated.

15 Generally, but not necessarily, adjustable focus lens 72 is set to focus on objects of interest held in wells 60 such as cells 64.

20 In an embodiment of the present invention, the optical data acquired is a high-resolution image of objects of interest, for example, images of cells 64 held in wells 64 of well-bearing component 54. Since the area of the high-resolution image acquired that corresponds to the image of each well 64 of interest is delineated according to the method of the present invention, automatized study of a specific individual well 60 or cell 64 with no overlap with neighboring objects and no identity confusion is simple. In an embodiment of the present invention, the data acquired by light responsive elements 76 of detection array 74 designated as corresponding to the image of a given well 60 are designated as being part of the image of the well 60 with no confusion or overlap with images of other wells 60.

25
30 Once the image of an individual well is delineated as described hereinabove, it is possible to use prior art image analysis methods to identify the borders of a cell held within a given individual well. Once the borders of a cell are determined it is a simple matter to estimate the volume or surface area of the cell. In some studies, it is informative to normalize detected signals relative to cell volume or cell surface area in order to make intercell comparisons.

- 33 -

In an embodiment of the present invention, data not designated as corresponding to images of wells 60 (for pixelated images, data not belonging to a group of pixels 99) is designated as corresponding to interwell area and is discarded as such data includes no useful information. In such a way, resources needed to store the data are reduced.

5 In an embodiment of the present invention, the optical data acquired is not a high-resolution image but rather signal data from objects of interest, for example light emitted by fluorescence of cells 64 or active entities held in wells 60 of well-bearing component 54.

10 In an embodiment of the present invention, exceptionally suitable for high-throughput screening methods, data corresponding to an acquired image of a single well is converted to a single signal. For example, the data from from all light responsive elements 76 of detection array 74 (or different colors summed separately, as may be appropriate) designated as corresponding to the image of a given well are summed. In such a way, observation component 70 is used as a multichannel detector, each channel
15 being the intensity of light (or the intensity of light of a certain color) detected as having been emitted from a specific well.

In an embodiment, optical data acquired is a high-resolution image of well-bearing component 54 as described above. The data (preferably excluding data corresponding to interwell areas) is stored. Either subsequently or simultaneously, data
20 acquired and designated as corresponding to each individual well 60 is summed so as to produce a single signal representative of the intensity of light impinging on detection array 74 from each individual well 60. When desired, all such signals are analyzed for certain characteristics (*e.g.*, intensity or time-dependent behavior). The high-resolution images corresponding to wells 60 associated with signals having the certain
25 characteristics are recovered and studied. In a preferred embodiment, the acquired high-resolution image of well-bearing component 54 is parsed into a plurality of high-resolution subimages, each subimage including only data corresponding to an image of a single well 60. Each such subimage is associated with a respective derived signal and independently stored for quick recovery. Such optical data storage is useful, for
30 example, when it is desired to confirm that a given noteworthy signal intensity (high or low) is produced by a whole cell, a cell fragment or an empty well. Such optical data storage also allows differentiation between empty wells identified as having little or no detected signal and filled wells holding cells that produce little or no detected signal.

- 34 -

Hereinabove, the method of the present invention has been disclosed where step S2 is followed by step S4, step S4 is followed by step S6 and step S6 is followed by step S8, an order chosen exclusively for convenience of description. As is clear to one skilled in the art, performance of step S8 is not dependent on performance of any of
5 steps S2, S4 or S6 and can be performed at any time before, after or during performance of steps S2, S4 or S6.

In a preferred embodiment of the present invention, the order of steps is as discussed hereinabove S2 followed by S4 followed by S6 followed by S8.

Since steps S4 and S6 are calculational steps dependent only on data acquired in
10 step S2, steps S4 and S6 are performed whenever convenient. For example, in embodiments of the present invention such as the embodiment described hereinabove, steps S4 and S6 are performed immediately after step S2 and prior to step S8. In other embodiments of the present invention, steps S4 and S6 are performed after both step S2 and step S8 have been performed. For example, in embodiments where step S2 and step
15 S8 include recording acquired images using a video camera as part of observation component 70, it is often convenient to digitize the acquired video data and subsequently perform steps S4 and S6 remotely from observation component (*i.e.*, off-line) after steps S2 and S8 are completed.

Whether data acquired in step S8 is time-dependent or not time-dependent (*e.g.*,
20 stills) in embodiments of the present invention S2 precedes S8 whereas in other embodiments of the present invention S8 precedes S2.

In a preferred embodiment of the present invention, multiple steps S2 and S8 are performed alternately. Such a preferred embodiment is exceptionally useful when step S8 includes the acquisition of time-dependent data and is even more exceptionally
25 useful when during step S8 there is motion of well-bearing component 54 in the X-Y plane, for example due to intermittent scanning of well-bearing component 54.

Reproductions of images produced according to the method of the present invention are depicted in Figure 12, Figures 13A and 13B and Figures 14A and 14B.

In Figure 12 is depicted an image of a well-bearing component 54 devoid of
30 cells 64 subsequent to steps S2, S4, S6 and S8. In Figure 12, grey areas 96 delineated by a black, substantially circular, line is composed of pixels displaying data from a high-resolution image of a well-bearing component 54 designated as corresponding to an individual well 60. For example, area 96a is an image made up of data acquired only

- 35 -

from a well designated 62. Between any two grey areas 96 is superimposed a simulated image of walls of wells 60 for the convenience of the viewer.

In Figures 13A and 13B are depicted two separate images of the same well-bearing component 54 holding MALT-4 cells.

5 In Figure 13A is depicted a high-resolution image of a well-bearing component 54 subsequent to step S2, step S4, step S6 and step S8. In some wells, 60 of well-bearing component 54 are held cells 64. As in Figure 12, an area 96 delineated by black, substantially circular, lines is composed of pixels displaying high-resolution image data acquired from a well-bearing component 54 designated as corresponding to an individual well 60. It is seen that an image 96a of an empty well 60a is grey whereas an
10 image 96b of a well 60b holding a cell 64 includes a high-resolution image of a respective cell 64. Between any two areas 96 is superimposed a simulated image of walls of wells 60 for the convenience of the viewer.

In Figure 13B is depicted a high-resolution image of fluorescence detected
15 coming from a well-bearing component 54 subsequent to a step S2, step S4, step S6 and step S8. In Figure 13B, areas delineated by white, substantially circular, lines are composed of pixels displaying data acquired from a well-bearing component 54 designated as corresponding to an individual well 60. It is seen that images of empty wells or images of wells holding non-fluorescent cells, such as 98, are black whereas in
20 images of wells holding fluorescent cells, such as 100, a fluorescent signal is apparent.

In Figures 14A and 14B are depicted two separate images of the same well-bearing component 54 holding MALT-4 cells.

In Figure 14A is depicted a high-resolution image of a well-bearing component 54 subsequent to step S2, step S4, step S6 and step S8 and a further cell delineation step.
25 In some wells, 60 of well-bearing component 54 are held cells 64. Subsequent to delineation of wells 60 as described hereinabove, image analysis was performed of each delineated well individually. As the borders of each well are delineated, it is a relatively simple matter to identify the borders of each cell against the background of the medium wherein the cells are found by an image analysis search only in the image of the well.
30 Thus, in Figure 14A, it is seen that cells 60 of interest are delineated by a black line. Subsequently, all data not corresponding to cells 60 of interest is deleted, saving data storage resources. When desired, all cells 60 of interest are displayed in a single uncluttered image, Figure 14B.

- 36 -

Hereinabove and in the Figures, the method of the present invention has been discussed where well-bottoms 62 are all substantially piano concave lens with a focal plane substantially parallel to the focal plane of observation component 70. Such a well-bottom shape is preferred for many reasons, including: a well-bearing component 54 having a planar lower surface 58 is simple to produce (see PCT patent application ILO1/00992) and a concave well-bottom is a natural shape for a well 60 configured to hold a cell 64. That said, the teachings of the present invention are applicable to substantially any shape of well-bottom.

As noted hereinabove and discussed hereinbelow, it is preferred that a well-bottom 62 have a C_{∞} rotation axis substantially perpendicular to the focal plane of observation component 70. In Figure 15 are depicted some, but not all, suitable well-bottom shapes in cross section, all having a C_{∞} rotation axis substantially perpendicular to the focal plane of observation component 70. In Figure 15, piano concave well-bottoms 102, bi concave well-bottom 104 and negative meniscus well-bottom 108 are substantially divergent lenses having an imaginary focal point $F\backslash$. When the method of the present invention is implemented using well-bottoms that are substantially divergent lenses, adjustable focus lens 72 is used to focus on imaginary focal point $F\backslash$. In Figure 15, positive meniscus lens 106, piano convex lenses 110 and 112 and biconvex lens 114 are substantially convergent lenses having a real focal point F . When the method of the present invention is implemented using well-bottoms that are substantially convergent lenses, adjustable focus lens 72 is used to focus on real focal point F .

In some embodiments of the present invention, well-bottoms 62 have a C_{∞} rotation axis that is not substantially perpendicular to the focal plane of observation component 70. In other embodiments, well-bottoms 62 do not have a C_{∞} rotation axis. The disadvantages of well-bottoms 62 not having a C_{∞} rotation axis perpendicular to the focal plane of the observation component are discussed hereinbelow.

Hereinabove and in the Figures, the method of the present invention has been discussed where each well-bottom 62 has a rotation axis perpendicular to the focal plane of observation component 70. One advantage of a well-bottom rotation axis perpendicular to the focal plane of observation component 70 is that a single observation component 70 is easily used to identify the center of an image of a well 60 as a reference point for delineating the borders of the well-image by acquiring an image of a real or imaginary focal point of the respective well-bottom 62. The fact that the

- 37 -

rotation axis is perpendicular to the the focal plane of observation component 70 means that for observation component 70 the image of the focal point is in the center of the image of the respective well 60. That said, in embodiments of the present invention, a well-bottom 62 does not have a rotation axis perpendicular to the focal plane of observation component 70. In such embodiments, the step of delineating the borders of an image of a well based on the image of a focal point of a respective well-bottom generally requires determination of an offset value.

Hereinabove and in the Figures, the method of the present invention has been discussed where each well-bottom 62 has a C_{∞} rotation axis. One advantage of a lens having a C_{∞} rotation axis is that the image of a focal point of such a lens is a point or a circle. As is clear to one skilled in the art, a point is a preferred shape for a reference point from which to delineate a circular or substantially circular well 62. As is clear to one skilled in the art and as described hereinabove, a circle-shaped image is easily converted to be a point or used as a reference point from which to delineate a circular or substantially circular well 62. An additional advantage of C_{∞} rotation axis is that any obstruction of light, for example, by the presence of a cell 64 held in a respective well 60b does not change the shape or location of the focal point image, as depicted in Figure 9. That said, in embodiments of the present invention, well-bottoms 62 do not have a C_{∞} rotation axis and consequently the image of a focal point is not necessarily a point or a circle. Examples include well-bottoms 62 having a C_2 rotation axis, a C_3 rotation axis or a C_4 rotation axis. Such well-bottoms are exceptionally useful, for example, when the shape of a respective well 60 is substantially not circular, *e.g.*, rectangular, triangular or square (see PCT patent application ILO 1/00992). Such well-bottoms are also exceptionally useful, for example, when there is significance to well orientation, for example when data is gathered for experiments performed under the influence of a magnetic field or during the flow of active compounds.

In an embodiment of the present invention, depicted in Figure 16, well-bearing component 54 has a substantially planar lower surface 58 and an upper surface 56 on which a plurality of rectangular wells 60 are disposed with "hull-shaped" well-bottoms 62 in Figure 16 having a C_2 rotation axis. As is clear to one skilled in the art, well-bottoms 62 are substantially divergent lenses producing an imaginary focal line. An image of such an imaginary focal line defines the long and short side of the image of each well 60, as well as the orientation of the respective well 60. Implementation of the

- 38 -

method of the present invention for wells, such as depicted in Figure 16, having a C_2 rotation axis including the retention of directional information is well within the ability of one skilled in the art upon perusal of the description and figures herein.

Hereinabove and in the Figures, the method of the present invention has been discussed where wells 60 are picowells and well-bearing component 54 is a carrier of a cell-chip device of PCT patent application ILO 1/00992. It is clear to one skilled in the art that the teachings of the present invention are applicable, with the appropriate modifications, to many different types of well-bearing components 54, including but not limited to well-bearing components such as multiwell plates having the well-known 6-well, 12-well, 48-well, 96-well, 384-well or 1536-well format, the well-bearing components described in PCT Patent Application No. IL04/000571 published as WO2004/1 13492 of the Applicant, and the well-bearing components described in PCT Patent Application IL04/00661 published as WO2005/007796 of the Applicant.

Hereinabove and in the Figures, the method of the present invention has been discussed where well-bottoms 62 are made of glass. Clearly a well-bottom 62 made of any material is suitable for implementing the teachings of the present invention as long as there exists at least one wavelength of light emitted by a locating light source 86 detectable by observation component 70, to which well-bottom 62 is substantially transparent and which is diffracted during passage through well-bottom 62. Suitable materials from which well-bottoms 62 of the present invention are made include materials mentioned in described in PCT Patent Application ILO 1/00992, in PCT Patent Application No. IL04/00571 or in PCT Patent Application IL04/00661. Such materials include but are not limited to gels, hydrogels, waxes, hydrocarbon waxes, crystalline waxes, paraffins, ceramics, elastomers, epoxies, glasses, glass-ceramics, plastics, polycarbonates, polydimethylsiloxane, polyethyleneterephthalate glycol, polymers, polymethyl methacrylate, polystyrene, polyurethane, polyvinyl chloride, rubber, silicon, silicon oxide and silicon rubber.

When implementing the teachings of the present invention using a well-bearing component made of a material having an index of refraction that is close to water as is disclosed in PCT Patent Application IL04/000571 published as WO2004/1 13492 of the inventor, there may be insufficient focusing of light passing through features of the well-bearing component to allow effective delineation of the borders of the images of the wells. In such embodiments, the steps related to acquiring the reference points or

- 39 -

features are preferably performed before water or physiological fluid is added to the wells of the well-bearing component. As the well-bearing component has an index of refraction near 1.33 and as the air filling the wells in such a situation has an index of refraction that is substantially 1.0, light passing through the well-bearing component is refracted to a sufficient degree to implement the teachings of the present invention. An added advantage of such an implementation is (as described in PCT Patent Application IL04/000571) that the well-bearing component becomes transparent and invisible in images acquired in steps subsequent to the addition of the water or physiological fluid.

Hereinabove and in the Figures, the method of the present invention has been discussed where locating light source 86 is below well-bearing component 54 and observation component 70 is above well-bearing component 54. Whereas in some embodiments of the present invention such a configuration is preferred, in other embodiments of the present invention it is preferred that locating light source 86 is above well-bearing component 54 and observation component 70 is below well-bearing component 54, as depicted in Figure 17. As is understood from Figure 15, such variation in configuration does not substantially influence the practice of the teachings of the present invention.

Hereinabove and in the Figures, the method of the present invention has been discussed where light produced by a locating light source 86 and passing through well-bottoms 62 is collimated by collimator 88. In a preferred embodiment of the present invention, images of focal points of well-bottoms 62 are acquired from substantially parallel light rays impinging on well-bottoms 62 in parallel to a rotation axis of well-bottoms 62. That said, embodiments of the present invention use non-collimated light, non-parallel light, or light that does not necessarily impinge in parallel to a rotation axis of a well-bottom 62. For example, in embodiments of the present invention it has been found that a diffuse locating light source 86 (*e.g.*, a standard microscope condenser) placed sufficiently far away from lower surface 58 of a well-bearing component 54 yields images of focal points of respective well-bottoms 62 that are sufficiently defined for implementing the teachings of the present invention.

The method of the present invention is manually implementable. That said, it is clear to one skilled in the art that it is preferable that many steps be performed automatically. As is known to one skilled in the art, the simplest and most convenient way for implementing an automatic embodiment of the method of the present invention

- 40 -

includes providing a computer device, such as control computer 84, together with appropriate hardware and software. All necessary hardware for implementing the teachings of the present invention is commercially available. Further, all software necessary for implementing the teachings of the present invention is commercially available or can be prepared by one skilled in the art without undue effort or experimentation upon perusal of the description and figures herein.

Hereinabove and in the Figures, the method of the present invention has been discussed where observation component 70 includes a digital camera equipped with a CCD sensor. Whereas in some embodiments of the present invention such an observation component is preferred (because CCD digital cameras pixelate images, because suitable CCD digital cameras are common and because CCD digital cameras are easily coupled to image processing components), in other embodiments of the present invention other types of observation components are used. Suitable observation components include but are not limited to digital cameras equipped with CMOS sensors, film cameras and video cameras. It is important to note that in embodiments where the image acquired by observation component 70 is not pixelated but where steps S4 and step S6 are digital processes, it is usually necessary to include a pixelation step. In some embodiments of the present invention, the desired data is continuously pixelated for image processing, as described above. In other embodiments, the desired data is recorded and only subsequently pixelated for image processing.

Immediately hereinabove an aspect of the present invention is discussed where the feature having optical properties used in identifying the image of an individual well is a well bottom. In a related aspect of the present invention, the features having optical properties used in identifying the image of an individual well is the well-walls. In the aspect of the present invention, the well-walls of a well-bearing component are utilised to delineate the images of individual wells from an image of a well-bearing component. Upon perusal of the description herein, one skilled in the art is aware that the aspect of the present invention employing the optical properties of well walls is analogous to the aspect discussed hereinabove where focal points of well-bottoms are used for determining a reference point for delineating an image of a well but instead of acquiring an image of a focal point of a well-bottom, an image of a focal line of well-walls is acquired.

- 41 -

The use of well-walls 126 as optically active features in accordance with the teachings of the present invention is schematically depicted in Figure 18. In Figure 18 is depicted, in cross-section, a well-bearing component 54 such as the well-bearing component depicted in Figure 7. Well-bearing component 54 is illuminated by light produced by a locating light source and passing through a collimator 88. Light passing through well-walls 126 diverges and is detected through adjustable focus lens 72. The light diverging from a well-wall 126 forms an imaginary focal line, F' . Adjustable focus lens 72 is adjusted so as to focus on or to approach focus of the produced imaginary focal lines such as F' . Once adequate focusing is achieved, an image of the focal line is acquired and used to delineate an image of a well in an image of a well-bearing device, substantially as described hereinabove.

In general, acquired are lines of light, arranged in a pattern corresponding to the pattern of the well-walls of the respective well-bearing component. For example, when the well-bearing component includes hexagonally-packed hexagonal wells (such as depicted in Figure 7) the image of focus lines acquired substantially resembles Figure HC. In an embodiment of the present invention, the lines of light are substantially found at the location of the images of the well-walls. In such embodiments, the detected focal lines are used directly to delineate borders of images of wells in an acquired image of a well-bearing component. In other embodiments, the detected focal lines are used as references to delineate borders of images of wells in an acquired image of a well-bearing component. Delineation of the borders of images of wells from focal lines of well-walls is analogous to delineation as described hereinabove for focal points of well-bottoms and is implementable by one skilled in the art upon perusal of the disclosure herein.

In a complementary aspect of the present invention somewhat different from the aspects discussed hereinabove, the wave-guiding properties of a well-bearing component are utilised to delineate the images of individual wells in an image of a well-bearing component. Such a use is schematically depicted in Figure 19. In Figure 19 is depicted, in cross-section, a well-bearing component 54 such as the well-bearing component depicted in Figure 7. Well-bearing component 54 is illuminated by light source 122 from the side. Light emitted from light source 122 enters well-bearing component 54 and is transported through well-bearing component 54 by internal reflection or total internal reflection in a manner analogous to the manner in which light

- 42 -

is guided, for example, through an optical fiber. However light 124 escapes through sharp and discontinuous features on the upper surface of well-bearing component 54 where the angle of light impinging is less than the critical angle. For example, in Figure 19 sharp and discontinuous features through which light escapes are edges 126 of well-walls 128. When escaping through the feature on the upper surface, the light is diffracted. An image of escaped light 124 is detected and acquired through adjustable focus lens 72.

A supplementary or additional mechanism by which light escapes is by the reflection or deflection of light transported through well-bearing component 54 by such features as bubbles, particles, occlusion bodies and other imperfections. As the light travels through well-bearing component 54, the light encounters such features and is deflected or reflected out of well-bearing component 54. When escaping well-bearing component 54, the deflected or reflected light is diffracted. As the light is deflected and reflected substantially randomly, well-bearing component 54 appears to glow. However, surface features such as well-walls 126 act as light paths, directing a significant portion of deflected light, by a process including internal reflection or total internal reflection, up through well-walls 128 to emerge through sharp edges 126 of well-walls 128 (Figure 19, detail).

Generally, two types of images are produced by escaped light 124 and acquired through adjustable focus lens 72, depending on the exact nature of sharp and discontinuous features of well-bearing component 54. In some embodiments of the present invention, detected are points of light corresponding to the pointed protrusion formed at the intersection of more than two wells 60 (see for example Figure 7). The points of lights are then used, using methods analogous to the methods described hereinabove, as reference points to delineate the borders of images of wells 60 in an acquired image of well-bearing component 54. In some embodiments of the present invention, detected are lines of light corresponding to well-walls 128 between two wells 60. The lines of light are then used, using methods analogous to the methods described herein, to delineate the borders of images of wells 60 in an acquired image of well-bearing component 54.

One of the advantages of using a well-bearing component 54 as a wave guide in accordance with the teachings of the present invention is that in some embodiments a separate focusing step (such as required in some embodiments of the second or third

- 43 -

general embodiments of the present invention) is not necessary. Rather, adjustable focus lens 72 is adjusted to acquire images of wells 60 or cells held therein or of light emitted therefrom (for example by fluorescence processes) as data. When a "data" image is acquired, an image of escaped light 124 is acquired simultaneously to produce a single
5 image including data and images formed by escaped light 124.

In an embodiment of the present invention, images produced by escaped light 124 are differentiated from other images by the regularity of the image produced.

In an embodiment of the present invention, light emitted by light source 122 is of specific wavelengths, a specific wavelength or of a limited range of wavelengths. For
10 example, when studying a process where green light is emitted by cells held in well-bearing component 54, light source 122 is configured to emit only red light. In such an embodiment the images produced by escaped light 124 are differentiated from other images by differentiation between green light images corresponding to data and red light images corresponding to escaped light 124.

In an embodiment of the present invention escaped light 124 is not acquired
15 simultaneously with acquisition of data from wells 60 or cells held within wells 60. In such an embodiment, data is acquired and escaped light 124 is acquired each in distinct steps. The delineation of the images of the wells in an image of a well-bearing component 54 is performed in a manner analogous to the manner described hereinabove
20 and is implementable by one skilled in the art upon perusal of the disclosure herein.

In a complementary aspect of the present invention somewhat different from the aspects discussed hereinabove, a well-bearing component having well-bottoms configured to focus light emitted from within a well is used.

An example of a device of the present invention including a well-bearing
25 component 130 having transparent refractive well-bottoms 62 configured to focus light emitted from within a respective well 60 is depicted in Figure 20. Well-bearing component 130 is substantially made of a material having an index of refraction lower than that of water (1.33) *e.g.*, a polytetrafluoroethylene such as Teflon® AF (E.I. du Pont de Nemours and Company, Wilmington, DE, USA) having a refractive index of
30 1.29 - 1.31. On upper surface 56 of well-bearing component 130 is found a plurality of wells 60, each well 60 configured to hold no more than one cell 64. Above upper surface 56 of well-bearing component 130, filling wells 60 and surrounding cells 64 is a physiological fluid such as water for maintaining the viability of cells 64. Functionally

- 44 -

associated with lower surface 58 of well-bearing component 130 is a substantially transparent spacer 134 separating well-bearing component 130 from a functionally associated planar light detector 132. Light detector 132 is any standard light detector including light-sensitive film or a pixelated light detector as described above.

5 Although well-bearing component 130 depicted in Figure 20 is separated from light detector 132 by spacer 134 allowing a stand-off distance for a greater degree of focusing and greater resolution of light focused by the bottoms of any two adjacent wells, in non-depicted embodiments of the present invention a light detector 132 is directly attached to lower surface 58 of a respective well-bearing component 130.

10 Although well-bearing component 130 depicted in Figure 20 is fashioned of substantially pure, solid polyfluoroethylene having an index of refraction less than that of the liquid filling wells 60, in embodiments of the present invention well-bearing component 130 is made of more than one material, for example a laminate or including a coated material. That said, transparent refractive well bottoms 62 of wells 60 are
15 configured to focus light emitted from within wells 60, for example by ensuring that the index of refraction of well bottoms 62 of wells 60 is less than that of the liquid filling wells 60.

 With reference to Figure 20, cells 64 held in wells 60b are exposed to a stimulus causing at least some cells 64 to emit light 136, or an indicator in well 60b to emit light
20 136. Light 136 passes from within an occupied well 60b filled with a liquid having a higher index of refraction through well bottom 62b having a lower index of refraction of well 60b of well-bearing component 130. As a result of the differences between the indicia of refraction, the concave shape of well bottoms 62b of wells 60b focus emitted light 136 through spacer 134 onto light detector 132. Not depicted in Figure 20 is that
25 light 136 is also diffracted at the interface between well-bearing component 136 and spacer 136.

 One advantage of the embodiment is that light signals produced by different cells 60 are differentiated. Even a small amount of focusing (and not necessarily point focusing depicted in Figure 20) ensures that light emitted by two cells held in
30 neighboring wells 60 is separated by a dark ring (analogous to the image depicted in Figure HA) allowing simple differentiation of signals produced by neighboring cells. An additional advantage is that focusing of emitted light improves the sensitivity and lower limit of detection of the device.

- 45 -

Generally fashioning a well-bearing component of the present invention from a material such as polytetrafluoroethylene is simple and generally follows procedures known to one skilled in the art and also discussed in PCT Patent Application No. IL04/000571 published as WO 2004/113492 that is included by reference as if fully set forth herein. It is important to note that many polytetrafluoroethylenes are exceptionally suitable for implementing the teachings of the present invention as polytetrafluoroethylenes are generally inert, non-absorbent as well as being substantially transparent to visible, ultraviolet and infrared radiation. Many types of polytetrafluoroethylene are also thermoplastic and accept fine details when contacted with a mold or form at the plastic temperature. An exemplary method used in fashioning devices from polytetrafluoroethylene having features of the same order of magnitude as a well-bearing component of the present invention is embossing using a silicon master prepared using conventional lithography techniques as taught, for example, by McKnight in the 2003 NNUN REU Program at Cornell NanoScale Facility.

15

It is appreciated that certain features of the invention, which are, for clarity, described in the context of separate embodiments, may also be provided in combination in a single embodiment. Conversely, various features of the invention, which are, for brevity, described in the context of a single embodiment, may also be provided separately or in any suitable subcombination.

20

Although the invention has been described in conjunction with specific embodiments thereof, it is evident that many alternatives, modifications and variations will be apparent to those skilled in the art. Accordingly, the present invention is intended to embrace all such alternatives, modifications and variations that fall within the spirit and broad scope of the appended claims. AU publications, patents and patent applications mentioned in this specification are herein incorporated in their entirety by reference into the specification, to the same extent as if each individual publication, patent or patent application was specifically and individually indicated to be incorporated herein by reference. In addition, citation or identification of any reference in this application shall not be construed as an admission that such reference is available as prior art to the present invention.

25

30

- 46 -

WHAT IS CLAIMED IS:

L A method of identifying an image of a well in an image of a well-bearing component, the well-bearing component having a lower surface, an upper surface and a side, the well disposed on the upper surface comprising:

passing light through the well-bearing component so that a portion of said light is refracted during said passage; and

acquiring an image of said refracted light.

2. The method of claim 1, wherein said acquiring an image is of light exiting the well-bearing component through a surface.

3. The method of claim 1, further comprising based on said image of said refracted light, identifying an area in an acquired image of the well-bearing component, said area to be considered as part of the image of the well.

4. The method of claim 1, further comprising based on said image of said refracted light, determining a reference point for identifying an area in an acquired image of the well-bearing component, said area to be considered as part of the image of the well.

5. The method of claim 1, wherein said light passed through the well-bearing component enters the well-bearing component through the side of the well-bearing component.

6. The method of claim 5, wherein said light entering the well-bearing component through the side of the well-bearing component is reflected at least once within the well-bearing component.

7. The method of claim 1, wherein said light passed through the well-bearing component enters the well-bearing component through a surface of the well-bearing component.

- 47 -

8. The method of claim 1, wherein said refracted light acquired is refracted by features on the lower surface of the well-bearing component.

9. The method of claim 1, wherein said refracted light acquired is refracted by features on the upper surface of the well-bearing component.

10. The method of claim 8 or 9 wherein said features correspond to a bottom of the well.

11. The method of claim 8 or 9 wherein said features correspond to walls of the well.

12. The method of claim 8 or 9, wherein said features correspond to intersections of the well with other wells disposed on the upper surface.

13. A method of identifying an image of a well in an image of a well-bearing component comprising:

illuminating the well-bearing component with a locating light source disposed on a first side of the well-bearing component; and
acquiring an image of a focal point of a feature of the well-bearing component produced by light from said locating light source passing through said feature.

14. The method of claim 13, wherein said feature is a border of said well.

15. The method of claim 14, wherein said border is a well-wall.

16. The method of claim 14, wherein said border is an intersection of the well with another well.

17. The method of claim 13, wherein said feature is a bottom of the well.

18. The method of claim 13, wherein said focal point is a real focal point.

- 48 -

19. The method of claim 13, wherein said focal point is an imaginary focal point.

20. The method of claim 13, further comprising based on said image of said focal point, identifying an area in an acquired image of the well-bearing component, said area to be considered as part of the image of said well.

21. The method of claim 13, further comprising based on said image of said focal point, determining a reference point for identifying an area in an acquired image of the well-bearing component, said area to be considered as part of the image of said well.

22. The method of claim 21, further comprising based on said reference point, delineating said area.

23. The method of claim 13, further comprising acquiring the image of the well-bearing component.

24. The method of claim 23, further comprising illuminating the well-bearing component with an observation light source.

25. The method of claim 23, further comprising:
providing an observation component for acquiring the image of the well-bearing component; and
adjusting the focus of said observation component so as to acquire an image of the well-bearing component.

26. The method of claim 23, further comprising based on said image of said focal point, determining a reference point for identifying an area in the acquired image of the well-bearing component, said area defined as part of the image of the well.

27. The method of claim 26, further comprising based on said reference point, delineating borders of said area defined as part of the image of the well.

- 49 -

28. The method of claim 27, further comprising:
providing an observation component for acquiring said image, said observation component including an array of light-responsive elements; and
designating the output of a group of light-responsive elements corresponding to said delineated area as corresponding to the image of the well.

29. The method of claim 27, further comprising summing signals making up said area so as to produce a limited number of signals characterizing said well.

30. The method of claim 29, wherein said acquired image of the well-bearing component is pixelated and said summing of signals is substantially summing pixels making up said area.

31. The method of claim 30, further comprising:
providing an observation component for acquiring said image, said observation component including an array of light-responsive elements; and
said summing up said pixels is substantially summing up output signals from said light-responsive elements.

32. The method of claim 30, wherein said signals have an intensity, said signal intensity related to an intensity of light arriving from a part of the well.

33. The method of claim 30, wherein said signals have an intensity, said signal intensity related to an intensity of a component frequency of light arriving from a part of the well.

34. The method of claim 13, further comprising:
providing an observation component for acquiring said image of said focal point,
and
adjusting the focus of said observation component so as to acquire an image of said focal point.

- 50 -

35. The method of claim 34, wherein said feature is a bottom of the well and wherein said adjusting the focus of said light-detection component is so that said image of said focal point of said bottom of the well is distinct from an image of a focal point produced by light passing through a bottom of a second well of the well-bearing component.

36. The method of claim 34, wherein said feature is a bottom of the well and wherein said adjusting the focus of said light-detection component is so that the size of said image of said focal point of said bottom of the well is substantially a minimum.

37. The method of claim 20, wherein said feature is a bottom of the well and further comprising defining said reference point as said image of said focal point.

38. The method of claim 20, wherein said feature is a bottom of the well and further comprising defining said reference point as the center of said image of said focal point.

39. The method of claim 27, wherein said feature is a bottom of the well and further comprising delineating said area defined as part of the image of the well as a circle about said reference point

40. A method for acquiring data comprising:

- a) providing a substantially planar well-bearing component having a lower surface, an upper surface, a plurality of wells and refractive features disposed on said upper surface and also providing an observation component configured to observe a first of said two surfaces;
- b) projecting light through said features from a second of said two surfaces;
- c) acquiring an image of a focal point of a said feature using said observation component;
- d) acquiring at least one image of said well-bearing component using said observation component; and

- 51 -

e) using said image of said focal point of said feature to determine a reference point for identifying an image of a respective well in said image of said well-bearing component.

41. The method of claim 40, wherein said features are borders of said wells.

42. The method of claim 41, wherein said borders are well-walls.

43. The method of claim 41, wherein said borders are intersections of wells with other wells.

44. The method of claim 40, wherein said features are bottoms of wells.

45. The method of claim 44, wherein said well-bottoms have a C_{∞} rotation axis.

46. The method of claim 45, wherein said C_{∞} rotation axis is substantially perpendicular to a focal plane of said observation component.

47. The method of claim 45, wherein said light is substantially parallel to said rotation axis.

48. The method of claim 40, wherein said first of said two surfaces is said lower surface and said second of said two surface is said upper surface.

49. The method of claim 40, wherein said first of said two surfaces is said upper surface and said second of said two surface is said lower surface.

50. The method of claim 40, wherein said focal point is an imaginary focal point.

51. The method of claim 40, wherein said focal point is a real focal point.

- 52 -

52. The method of claim 40, further comprising prior to c, adjusting the focus of said observation component.

53. The method of claim 52, wherein said features are bottoms of wells and wherein said adjusting the focus of said observation component is to an extent where two images of two focal points produced by two well-bottoms are distinct.

54. The method of claim 53, wherein said adjusting the focus of said observation component is to an extent where the size of said image of said focal point is substantially minimal.

55. The method of claim 40, wherein said acquiring at least one image of said well-bearing component includes detecting light emitted by fluorescence.

56. The method of claim 40, wherein said acquiring at least one image of said well-bearing component includes detecting light reflected from said first of said two surfaces.

57. The method of claim 40, further comprising, prior to d, adjusting the focus of said observation component to focus on contents of said wells disposed on said upper surface of said well-bearing component.

58. The method of claim 40, further comprising, prior to d, adjusting the focus of said observation component to focus on said wells disposed on said upper surface of said well-bearing component.

59. The method of claim 40, further comprising using said reference point for delineating a border of said image of said respective well in said image of said well-bearing component.

60. The method of claim 59, wherein said features are bottoms of wells and wherein said border delineated is substantially a circle about said reference point.

- 53 -

61. The method of claim 40, wherein said reference point is said image of said focal point.

62. The method of claim 40, wherein said features are bottoms of wells and wherein said reference point is the center of said image of said focal point.

63. The method of claim 40, wherein c precedes d.

64. The method of claim 40, wherein d precedes e.

65. The method of claim 40, wherein during d, a plurality of time-dependent images of said well-bearing components are acquired.

66. The method of claim 65, wherein c is performed during d.

67. The method of claim 66 wherein c is performed more than once during d.

68. The method of claim 40, further comprising, pixelating said image of said well-bearing component.

69. The method of claim 68, further comprising, based on said reference point designating a group of pixels as corresponding to said image of a respective said well.

70. The method of claim 68, further comprising, summing values related to said group of pixels so as to yield a signal characteristic of said respective said well.

71. The method of claim 70, wherein said values are related to an intensity of light acquired by said observation component from a part of said respective said well.

72. The method of claim 70, wherein said values are related to an intensity of component frequencies of light acquired by said observation component from a part of said respective said well.

- 54 -

73. The method of claim 40, further comprising storing said at least one image of said well-bearing component.

74. The method of claim 73, wherein said at least one image is stored as digital data.

75. The method of claim 74, further comprising, prior to said storing, reducing the amount of said digital data stored by removing data not corresponding to images of said wells.

76. A device for the study of cells comprising:

- a) a well-bearing component having a lower surface, an upper surface and a side;
- b) a plurality of wells disposed on said upper surface; and
- c) a light source configured to illuminate said well-bearing component through said side.

77. The device of claim 76, wherein said well-bearing component is configured to act as a wave-guide for light produced by said light source.

78. A method for the study of cells, comprising:

- a) providing a well-bearing component having a lower surface, an upper surface and a plurality of wells disposed on said upper surface, said wells configured to hold at least one living cell wherein bottoms of said wells are configured to focus light emitted from within a said well and passing through a said well bottom;
- b) holding a liquid in said wells; and
- c) detecting light emitted from within a said well and passing through said a well bottom.

79. The method of claim 78, wherein said emitted light is emitted by a cell held in a said well.

- 55 -

80. The method of claim 78, wherein said emitted light is emitted as a result of a material released by a cell held in a said well.

81. The method of claim 78, wherein said bottoms of said wells are fashioned of a material having an index of refraction lower than that of said liquid.

82. A device for the study of cells comprising:

- a) a well-bearing component having a lower surface and an upper surface; and
- b) a plurality of wells disposed on said upper surface, said wells configured to hold at least one living cell

characterized in that said wells have well-bottoms configured to focus light emitted from within a said well and passing through a said well bottom

83. The device of claim 82, wherein said wells have well-bottoms fashioned of a material having an index of refraction lower than that of water.

84. A device for the study of cells comprising:

- a) a well-bearing component having a lower surface and an upper surface;
- b) a plurality of wells disposed on said upper surface, said wells configured to hold at least one living cell; and
- c) a liquid held in said wells

characterized in that said wells have well-bottoms fashioned of a material having an index of refraction lower than that of said liquid.

85. The device of claim 82 or 84, further comprising:

- d) a substantially planar light detector functionally associated with said lower surface.

86. The device of claim 85, further comprising:

- e) a spacer positioned between said lower surface and said light detector.

87. The device or method of claim 81, 83 or 84, wherein said index of refraction is less than 1.33.

- 56 -

88. The device or method of claim 81, 83 or 84, wherein said well-bearing component essentially consists of said material.

89. The device or method of claim 81, 83 or 84, wherein said well-bearing component consists of said material.

90. The device or method of claim 81, 83 or 84, wherein said material is polytetrafluoroethylene.

91. The device or method of claim 76, 78, 83 or 84, wherein a bottom surface of said wells is concave.

92. The device or method of claim 76, 78, 83 or 84, wherein said wells are juxtaposed.

93. The device or method of claim 92, wherein the interwell area between two said wells is less than about 0.35 the sum of the areas of said two wells.

94. The device or method of claim 92, wherein a rim of a said well is substantially knife-edged.

95. The device or method of claim 76, 78, 82 or 84, wherein the dimensions of said wells are less than about 200 microns.

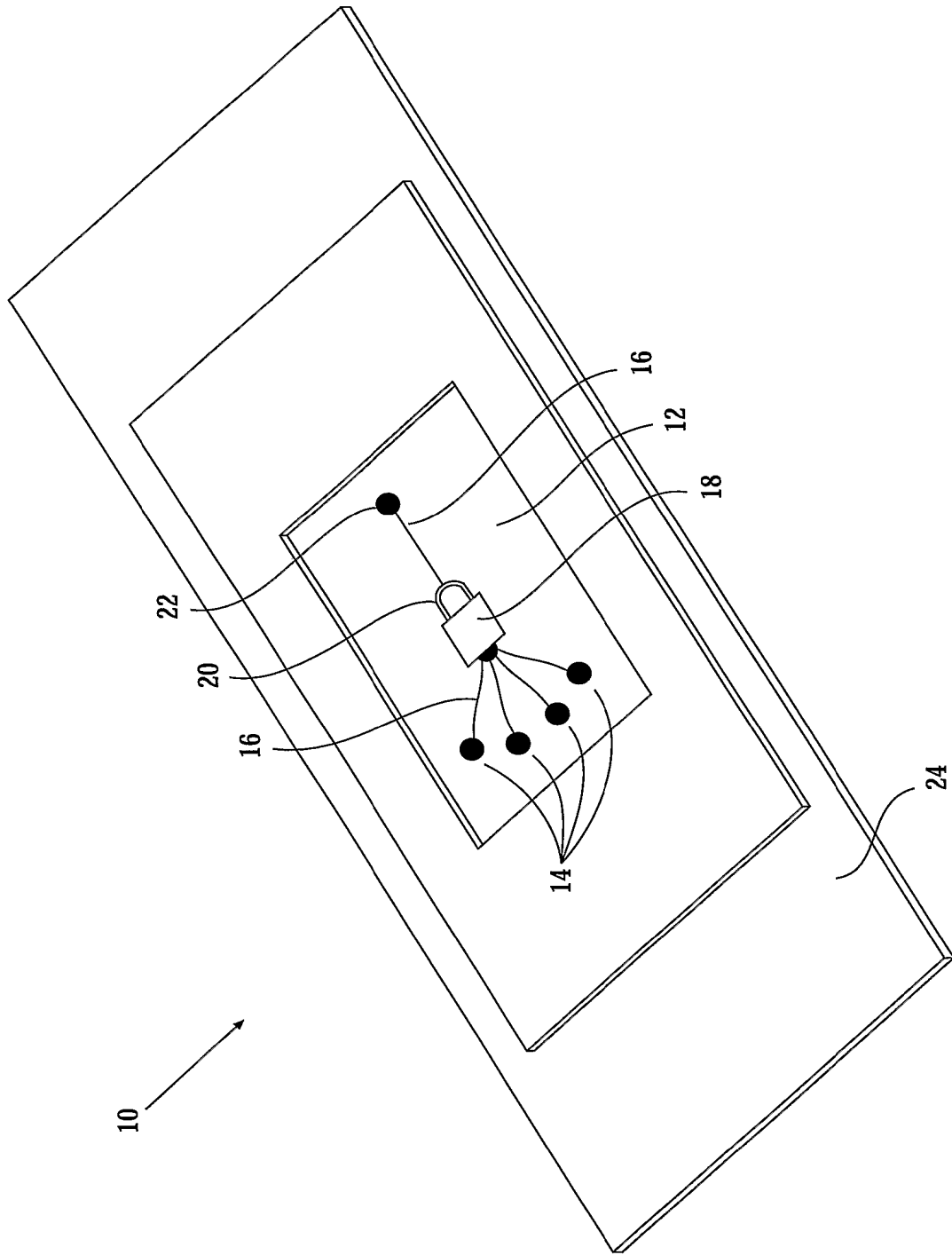

FIG. 1 (PRIOR ART)

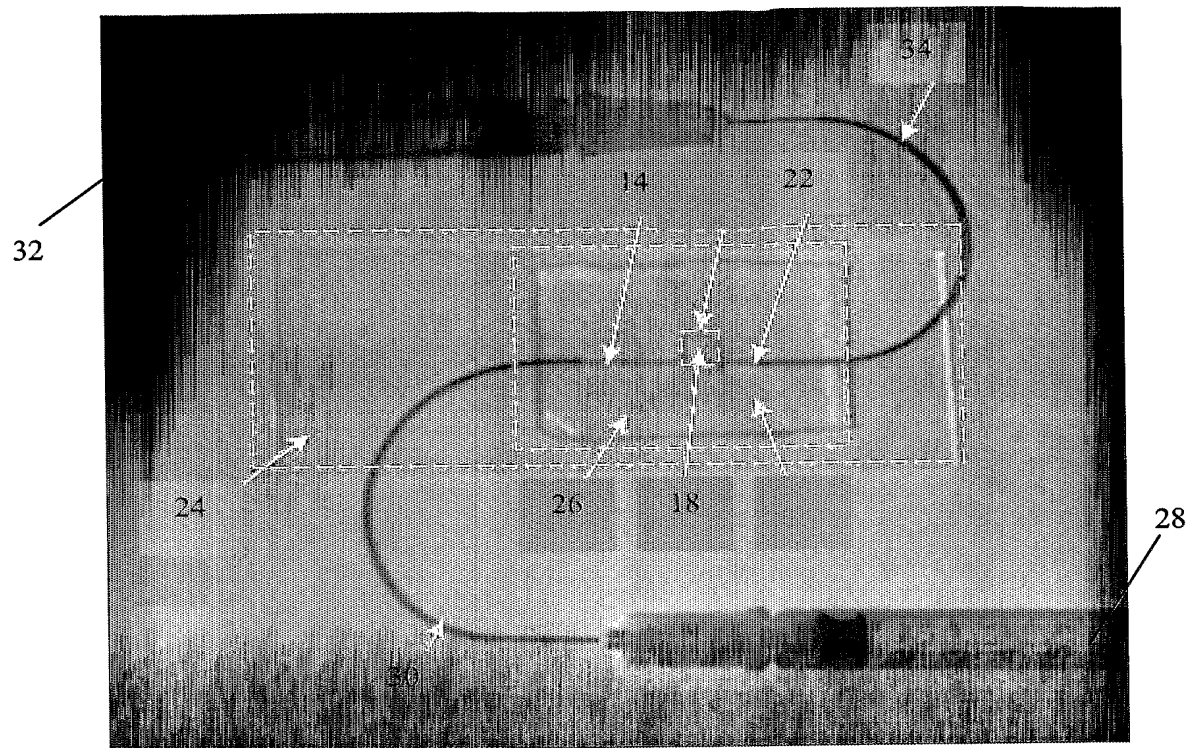

FIG. 2 (PRIOR ART)

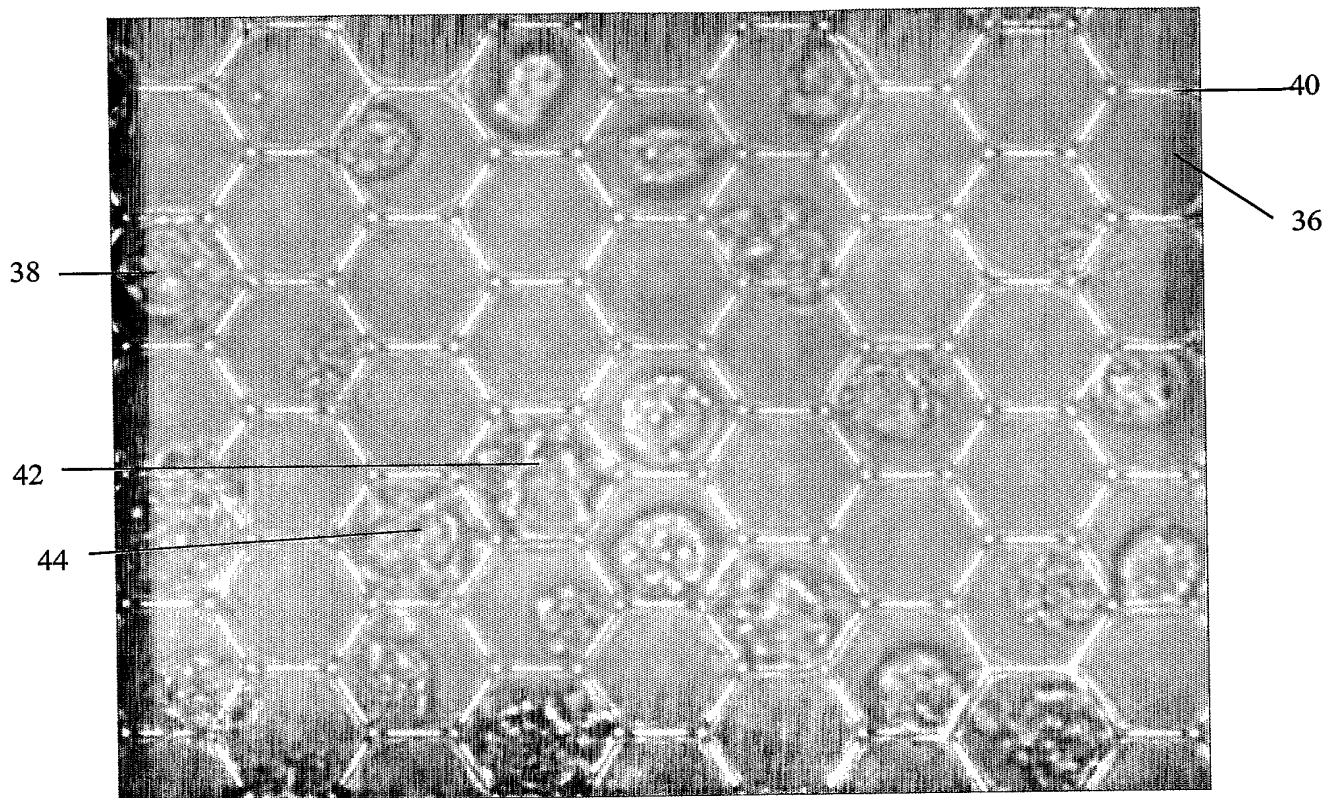

FIG. 3 (PRIOR ART)

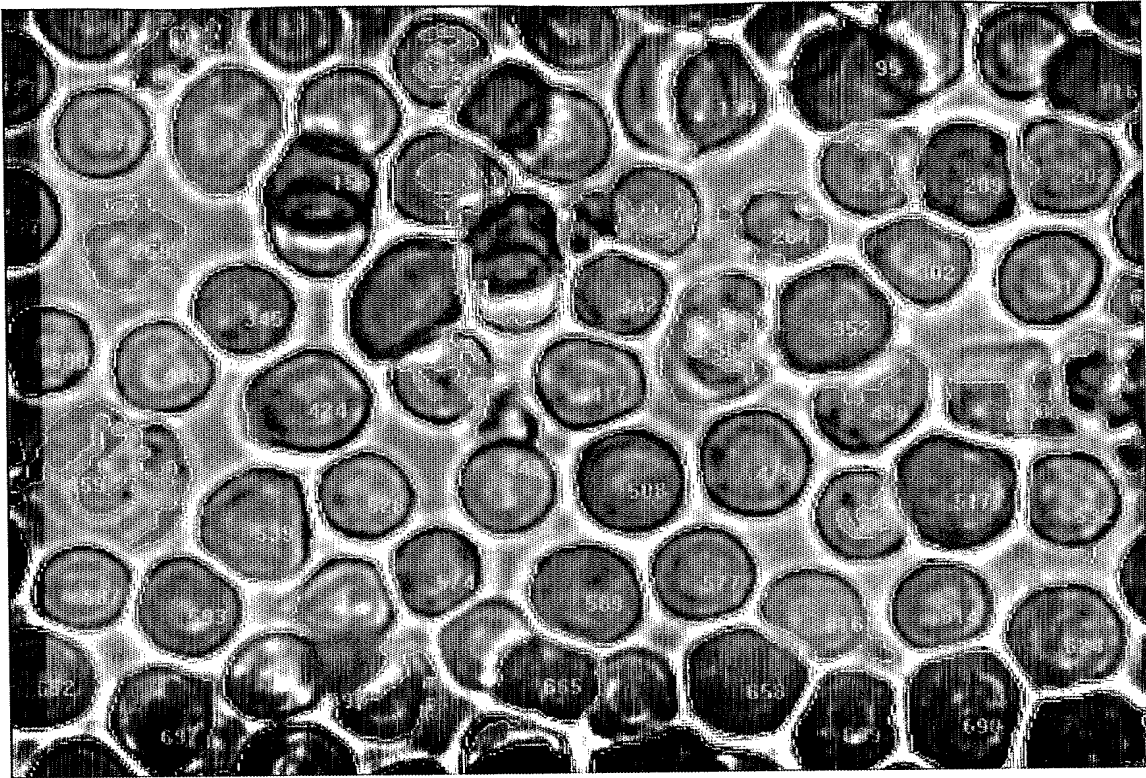

FIG. 4 (PRIOR ART)

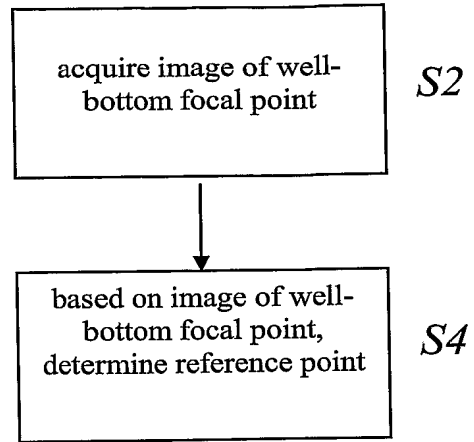

FIG. 5A

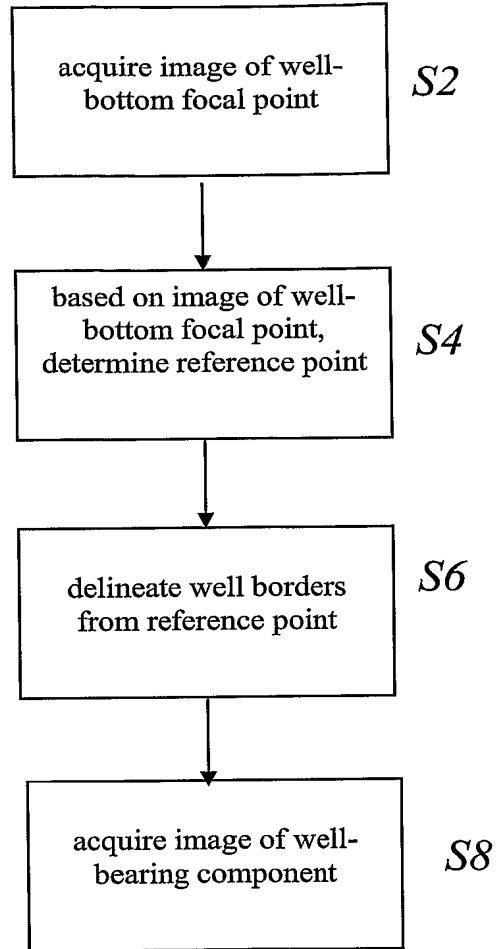

FIG. 5B

7/28

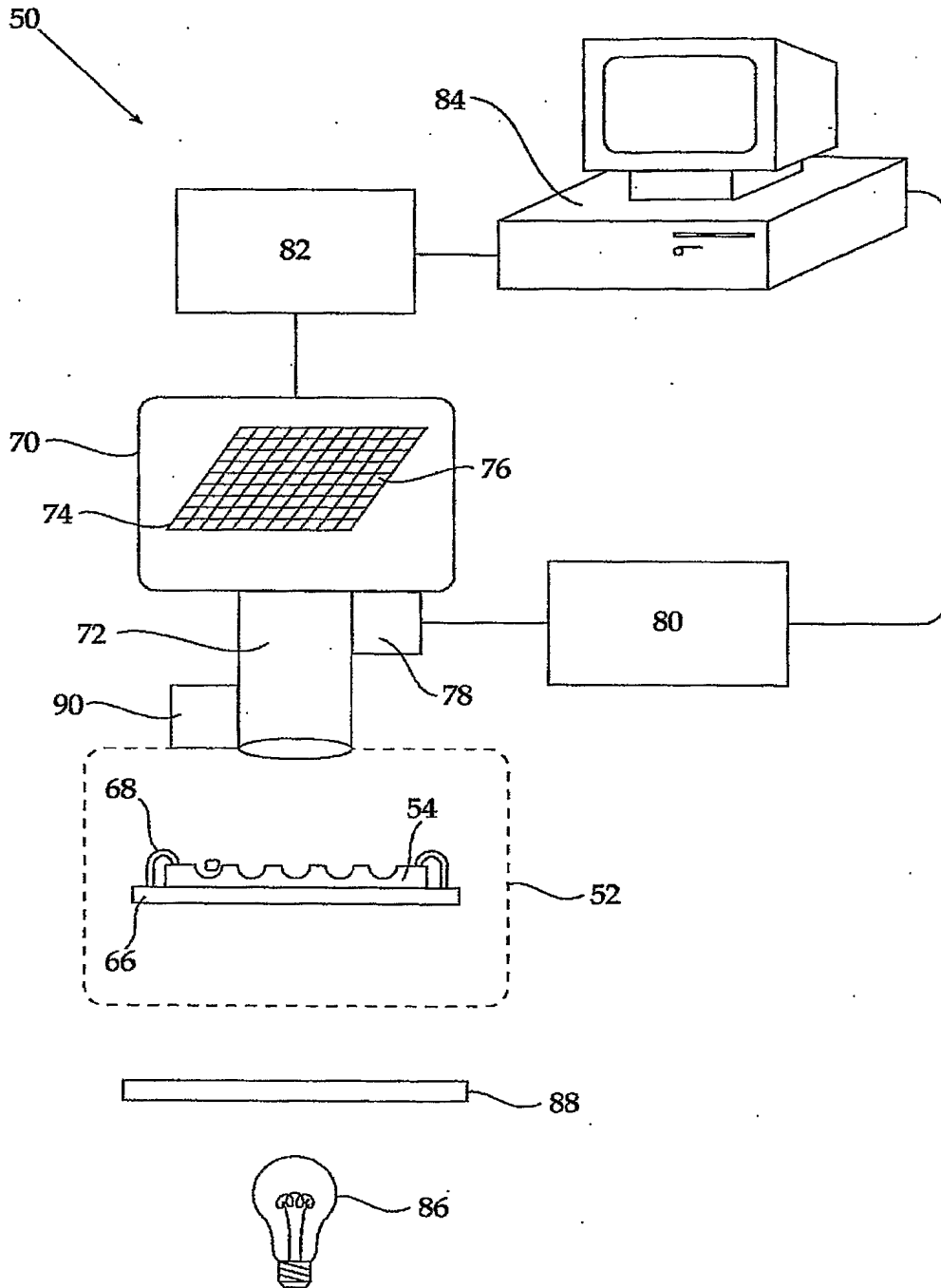

FIG.6A

8/28

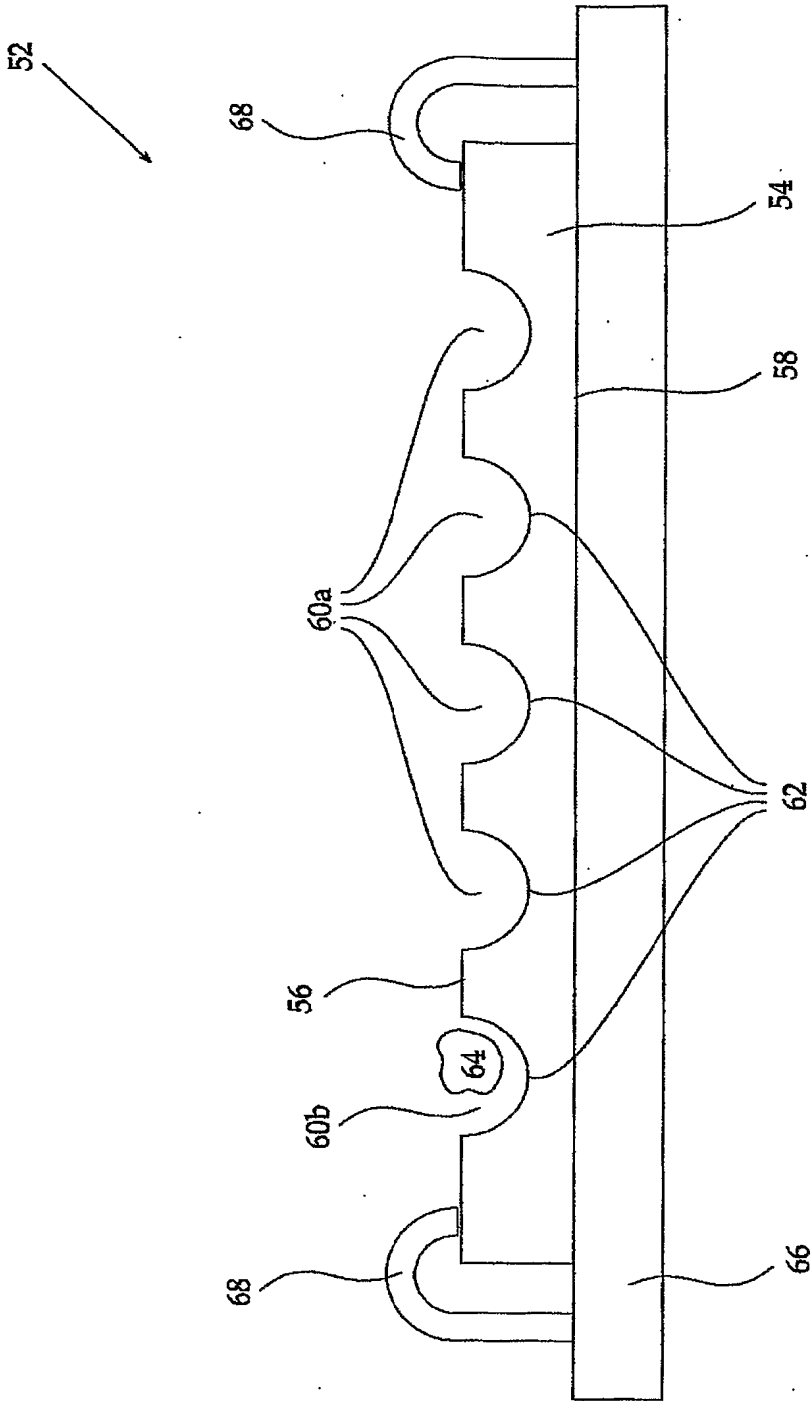

FIG.6B

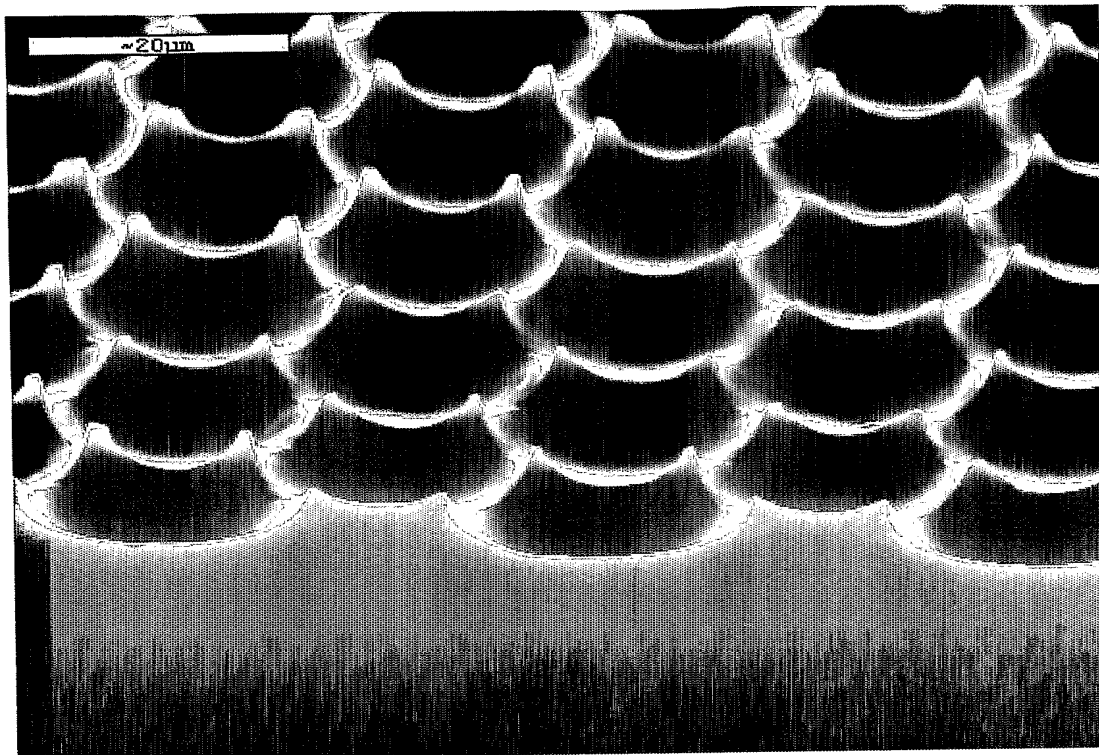

FIG. 7

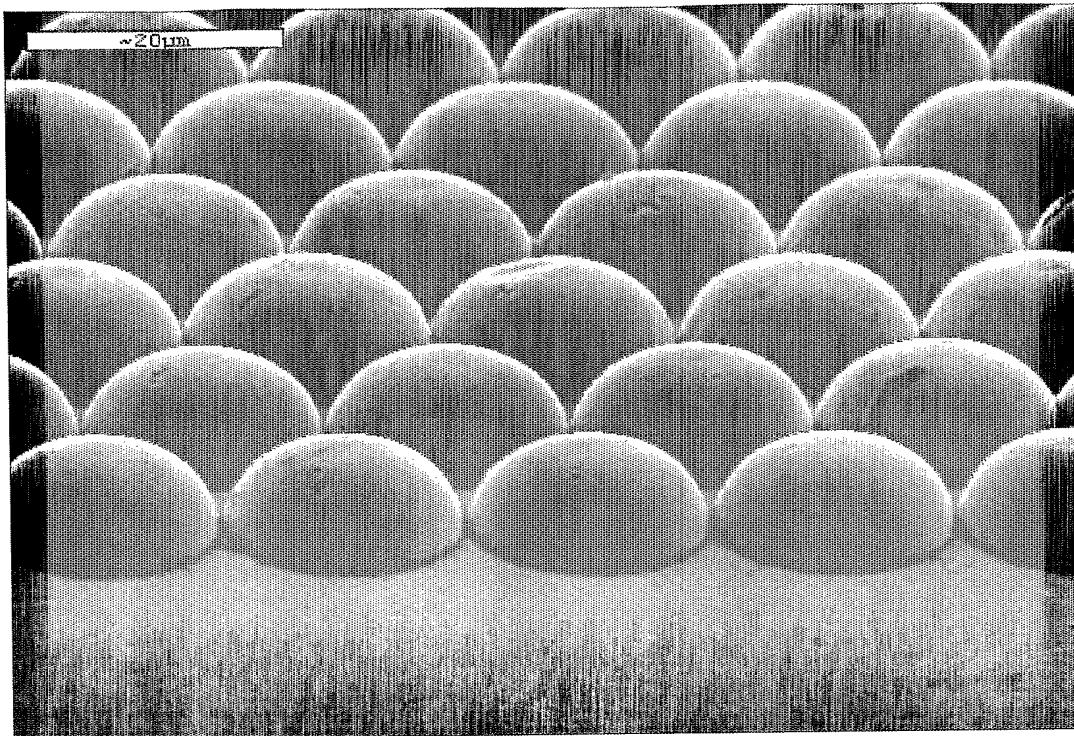

FIG. 8

11/28

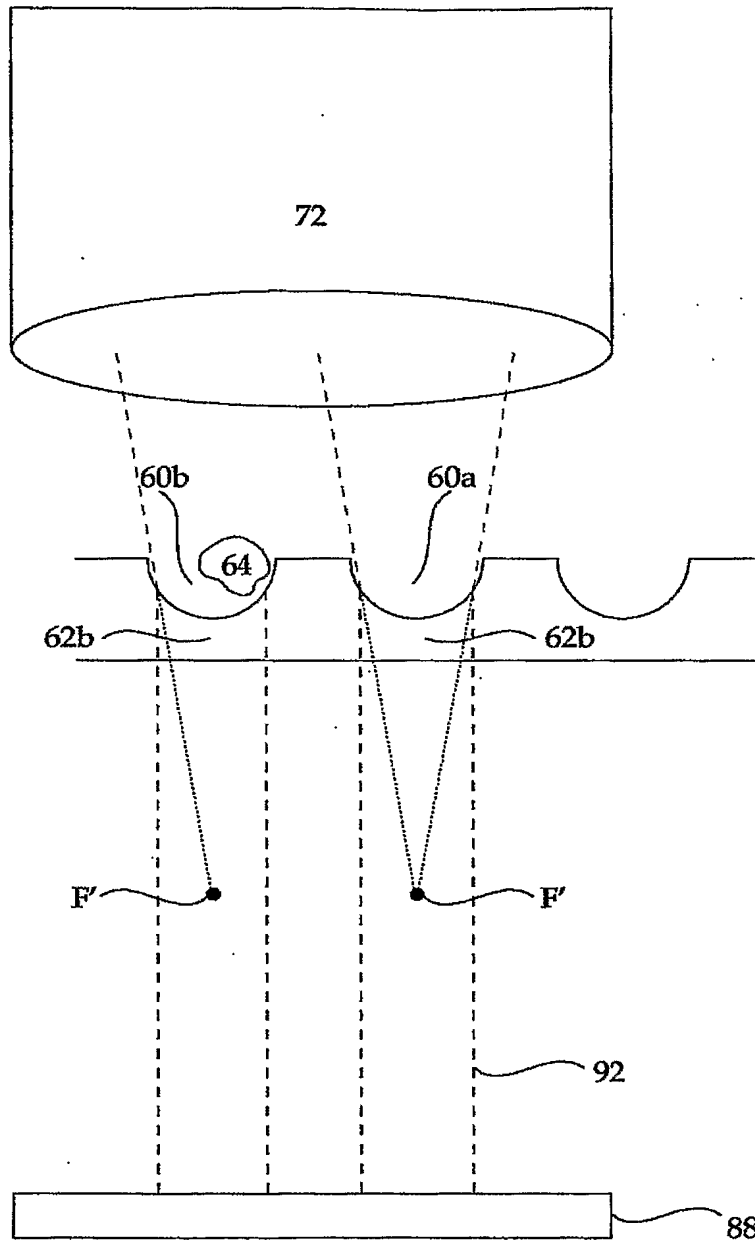

FIG.9

12/28

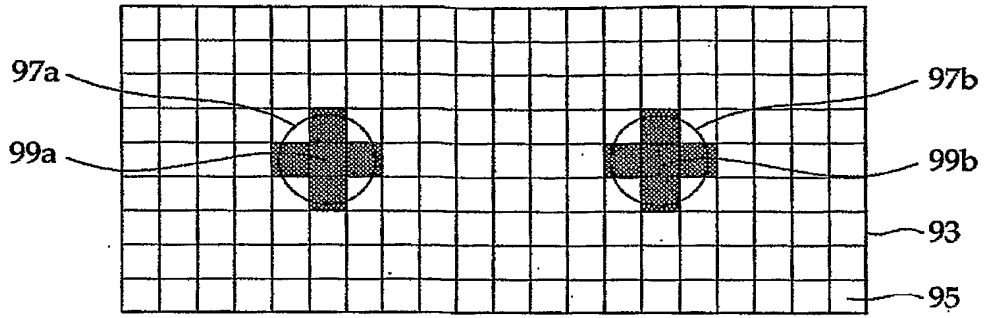

FIG. 10A

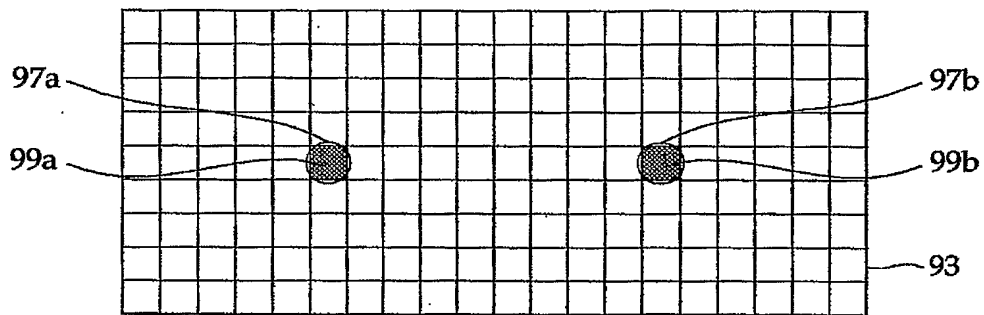

FIG. 10B

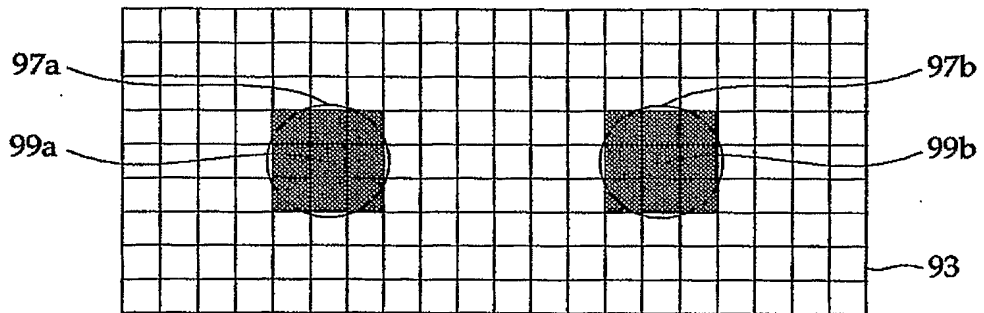

FIG. 10C

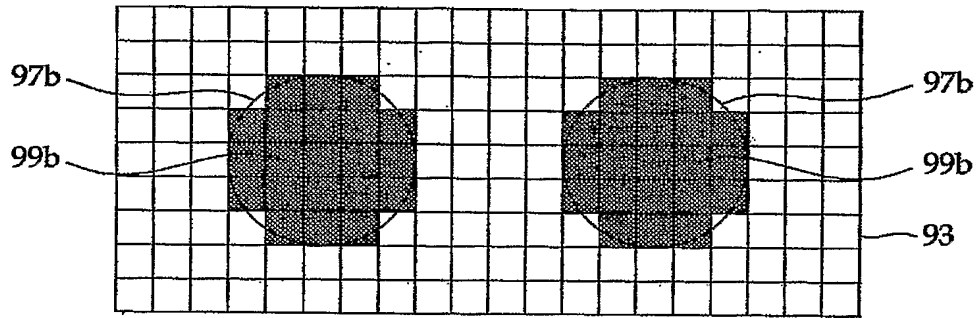

FIG. 10D

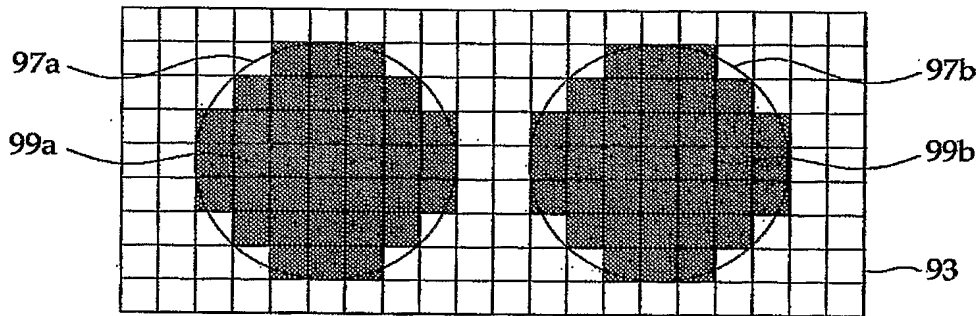

FIG. 10E

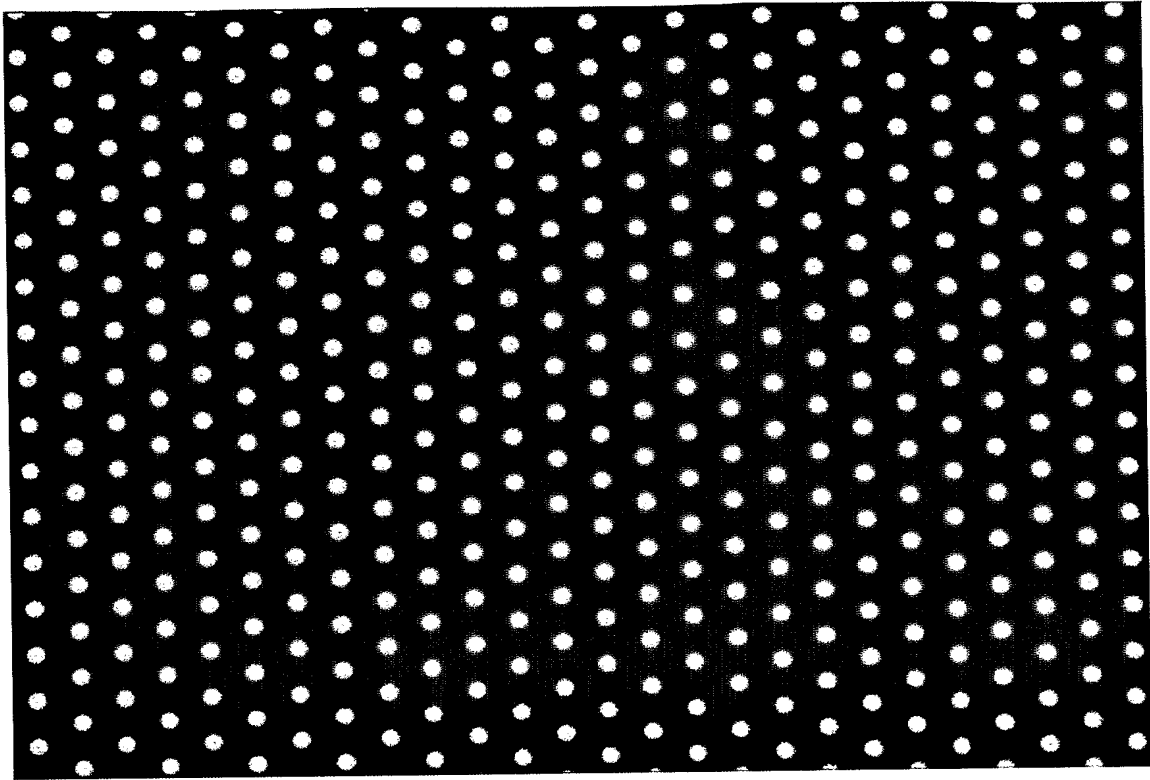

FIG. 11A

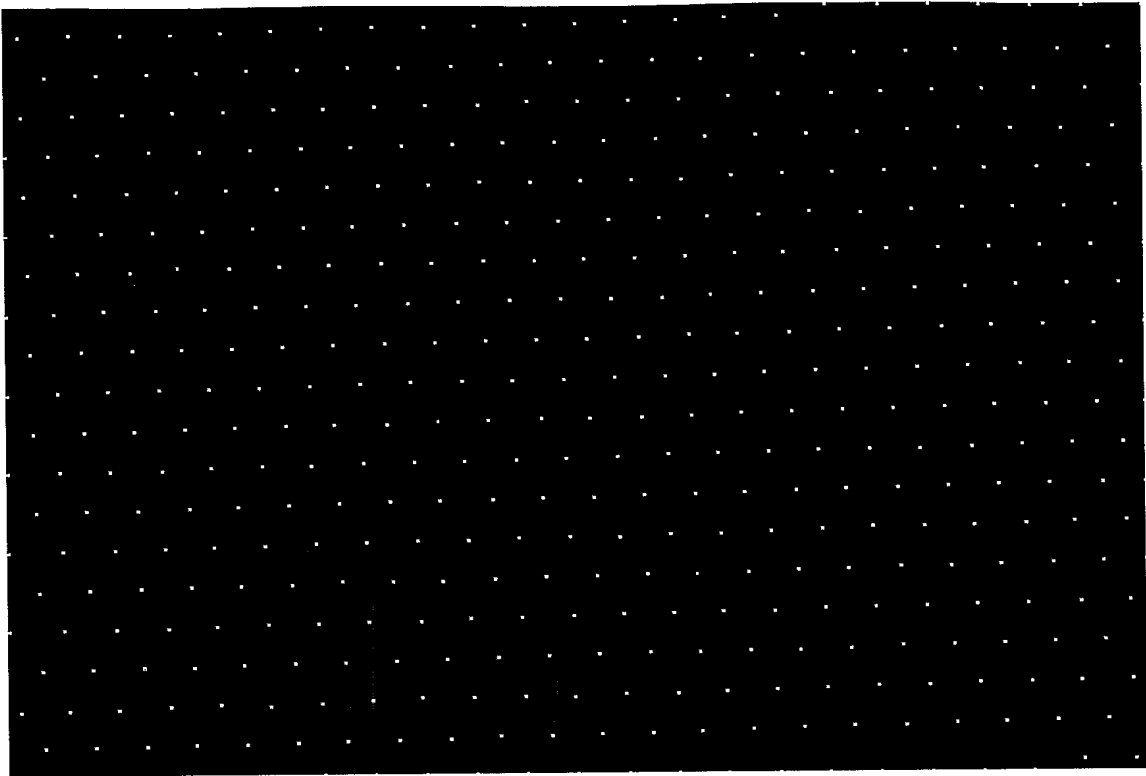

FIG. 11B

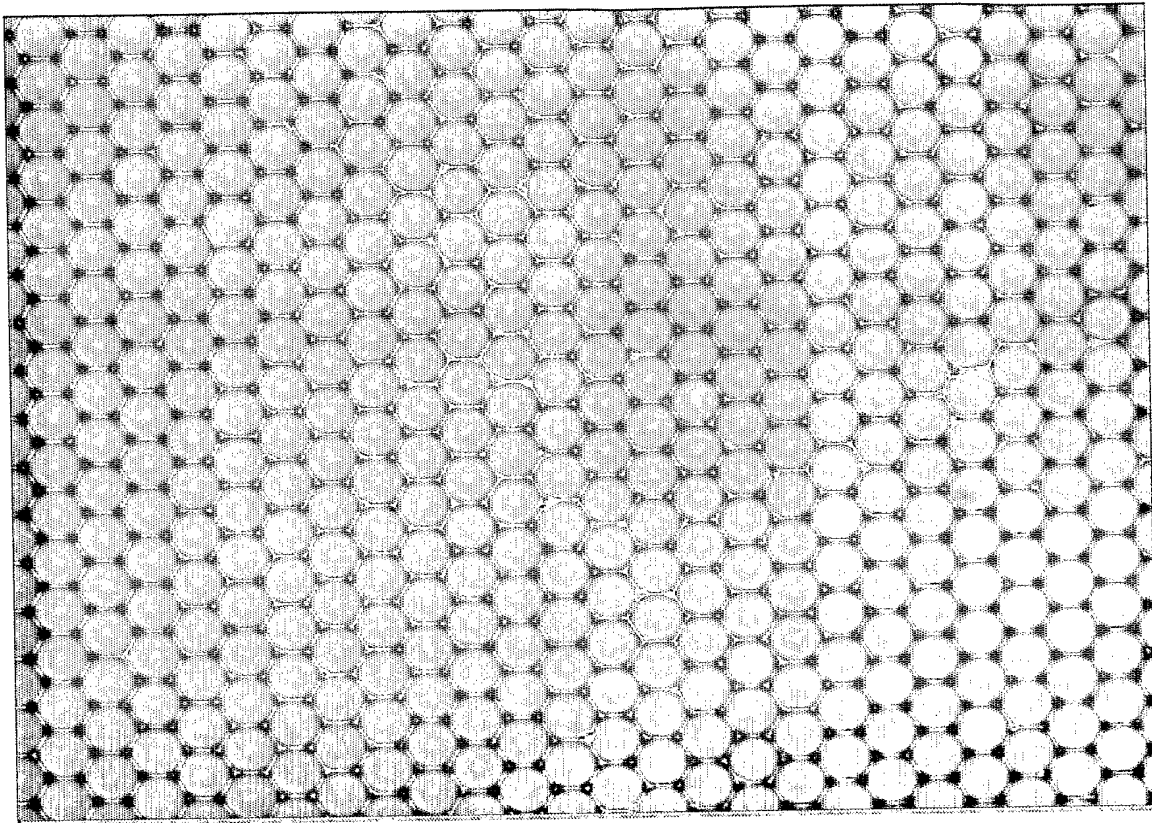

FIG. 11C

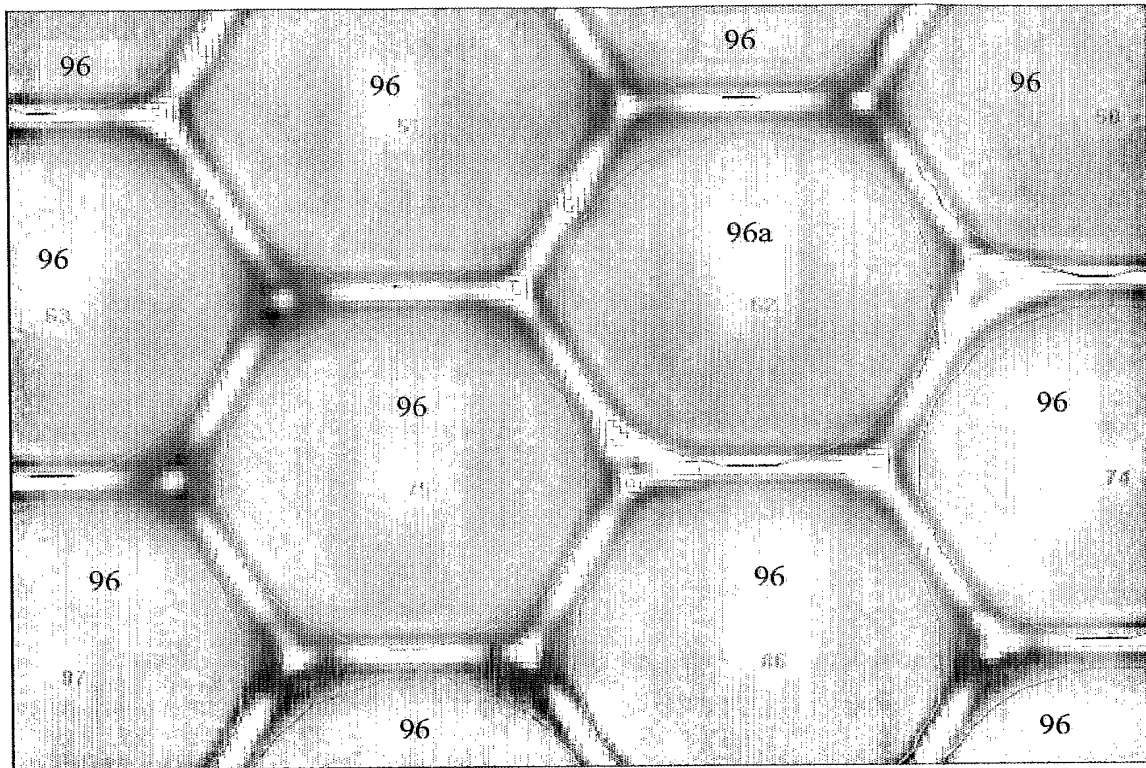

FIG. 12

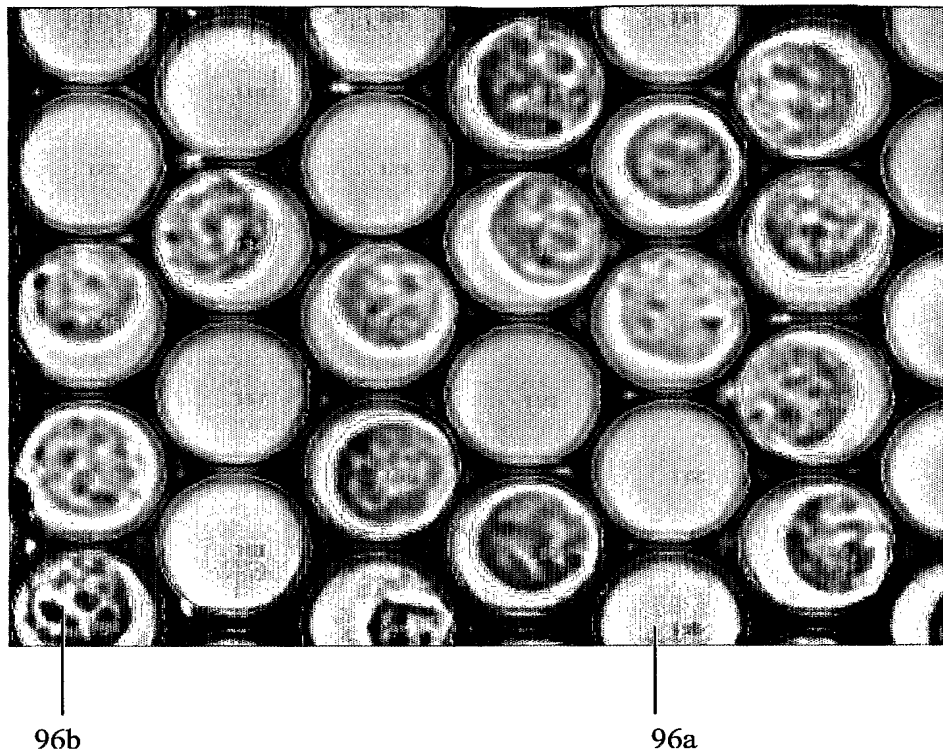

FIG. 13A

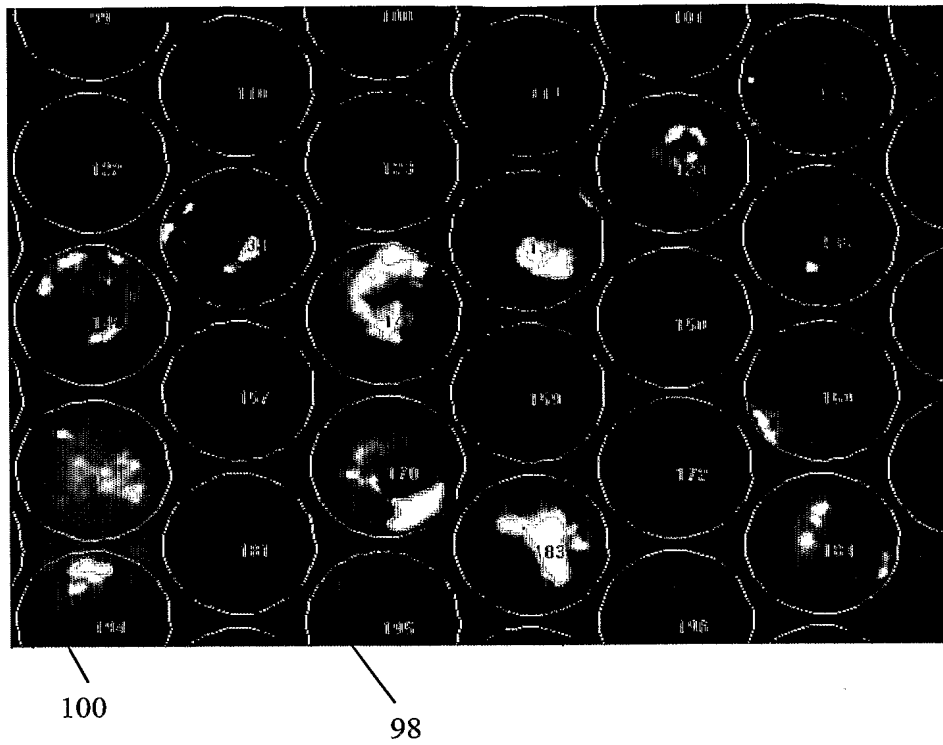

FIG. 13B

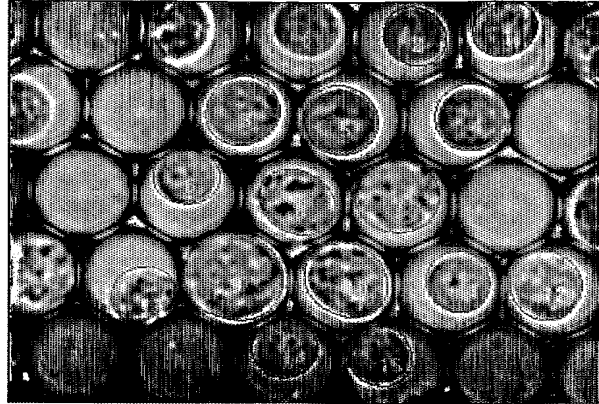

FIG. 14A

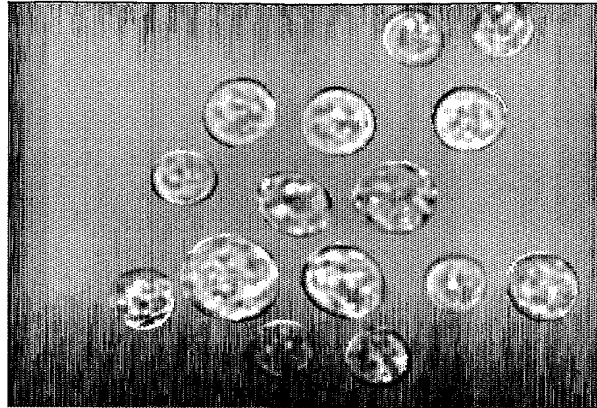

FIG. 14B

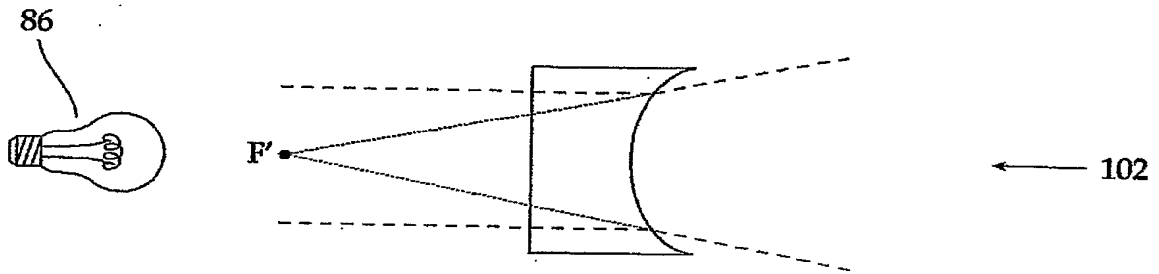

FIG. 15A

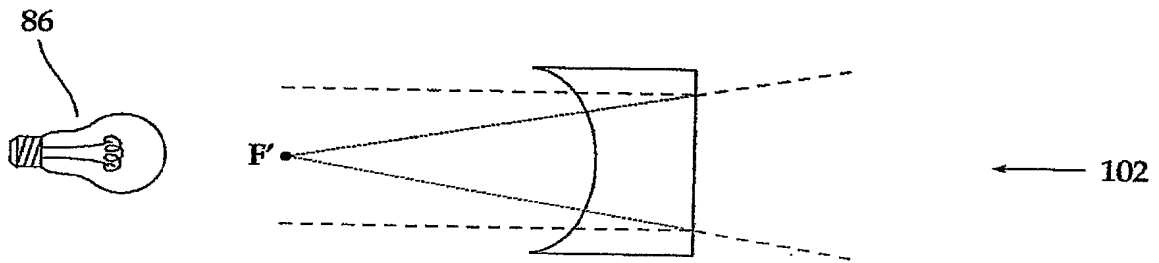

FIG. 15B

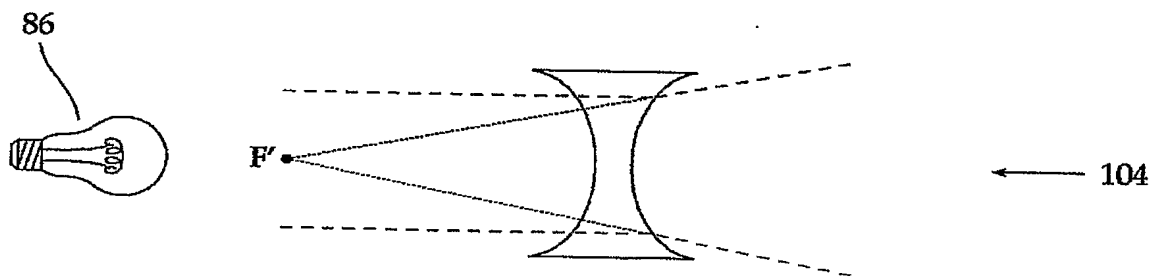

FIG. 15C

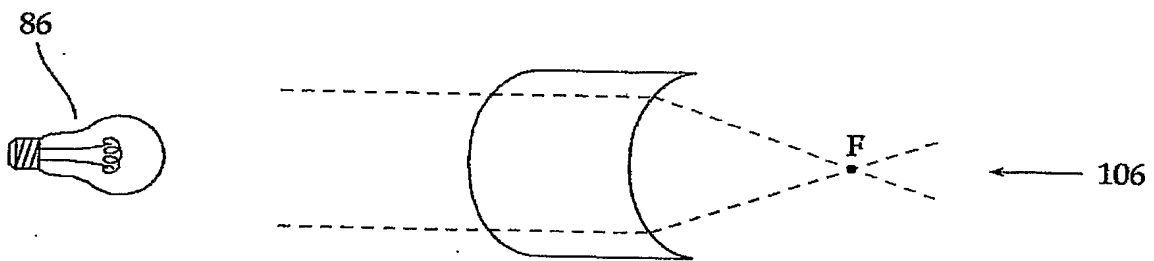

FIG. 15D

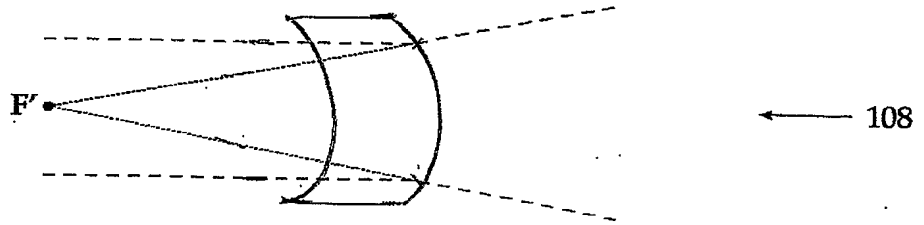
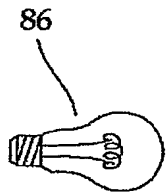

FIG. 15E

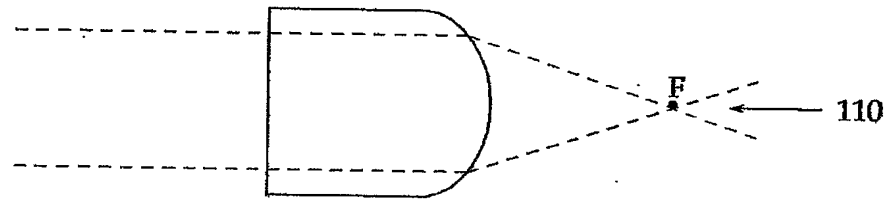
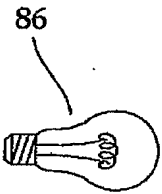

FIG. 15F

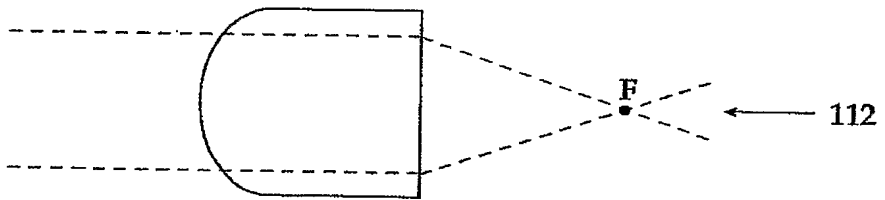
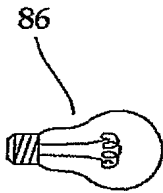

FIG. 15G

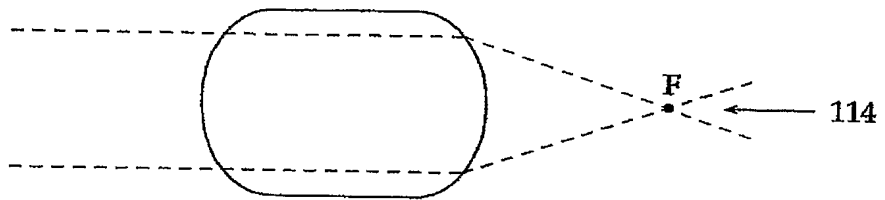
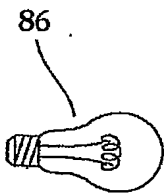

FIG. 15H

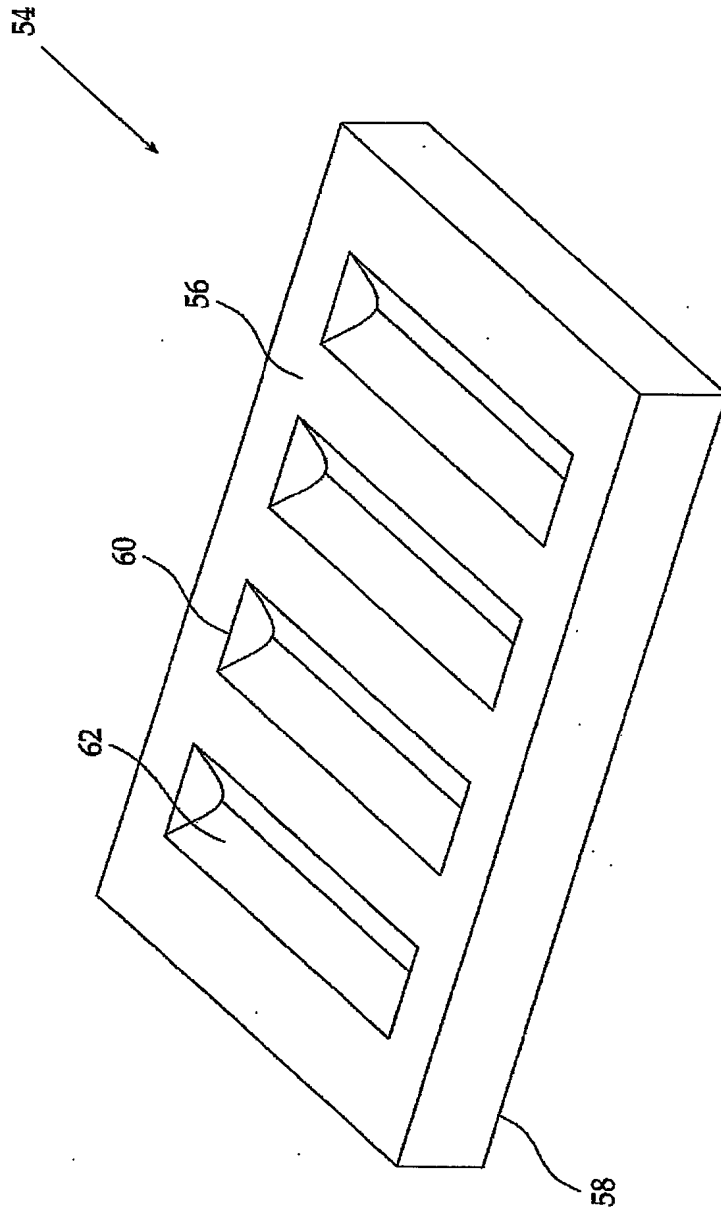

FIG. 16

25/28

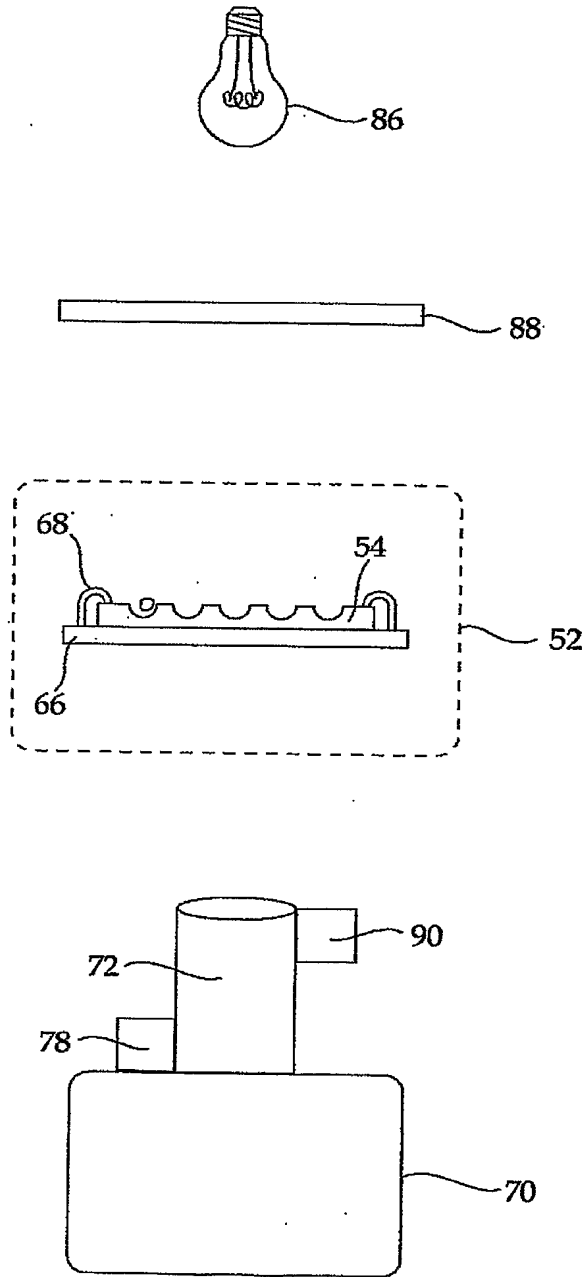

FIG.17

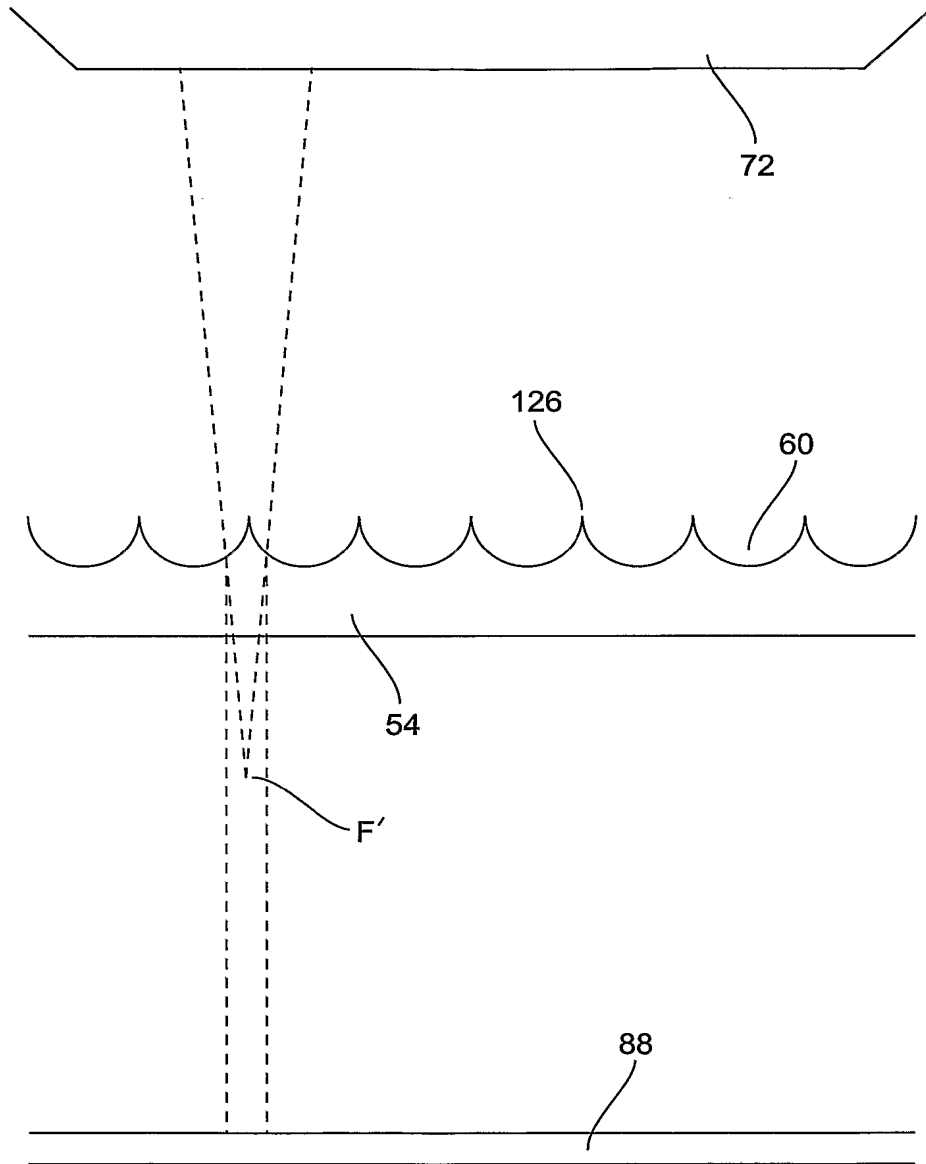
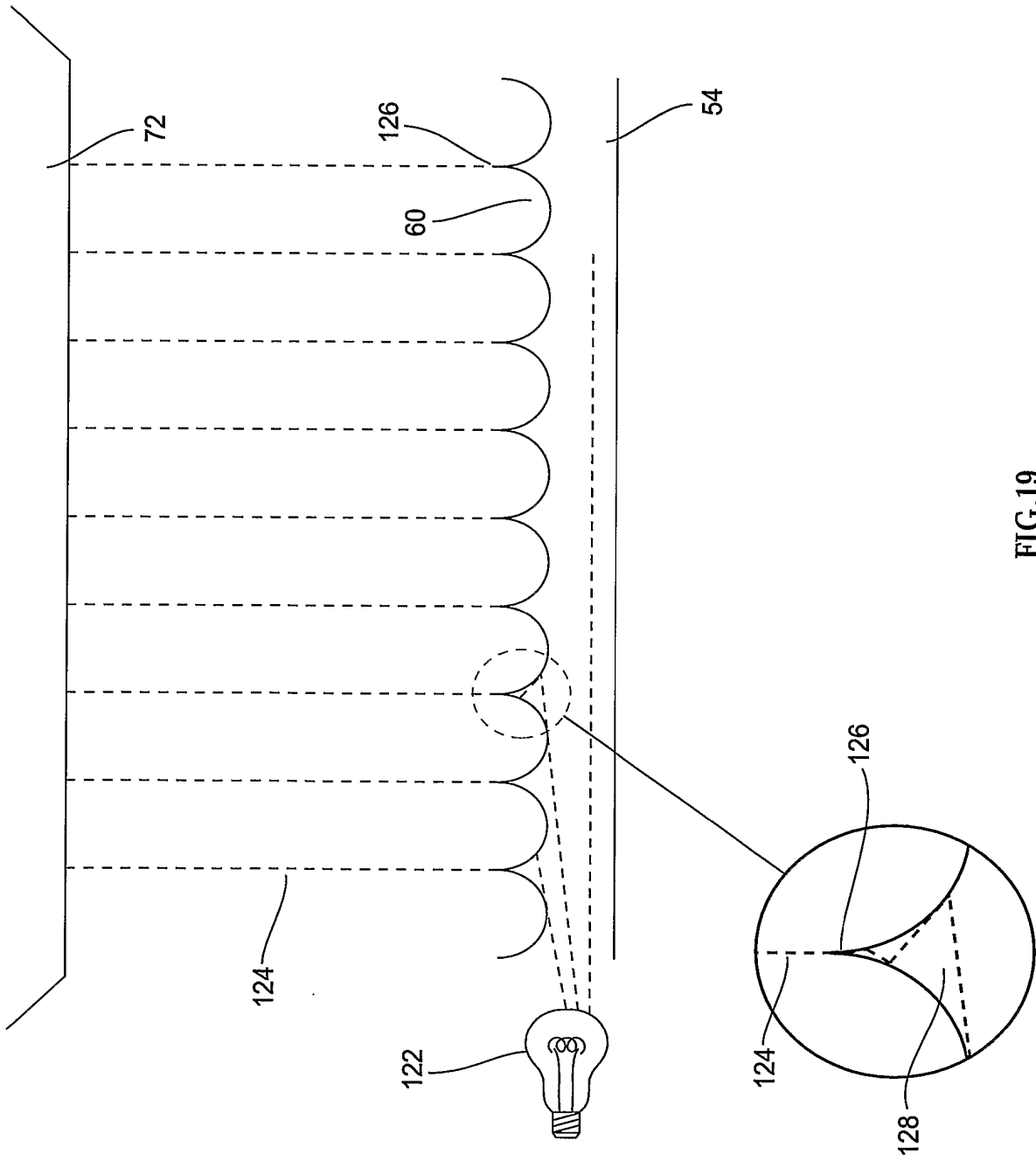

FIG.18



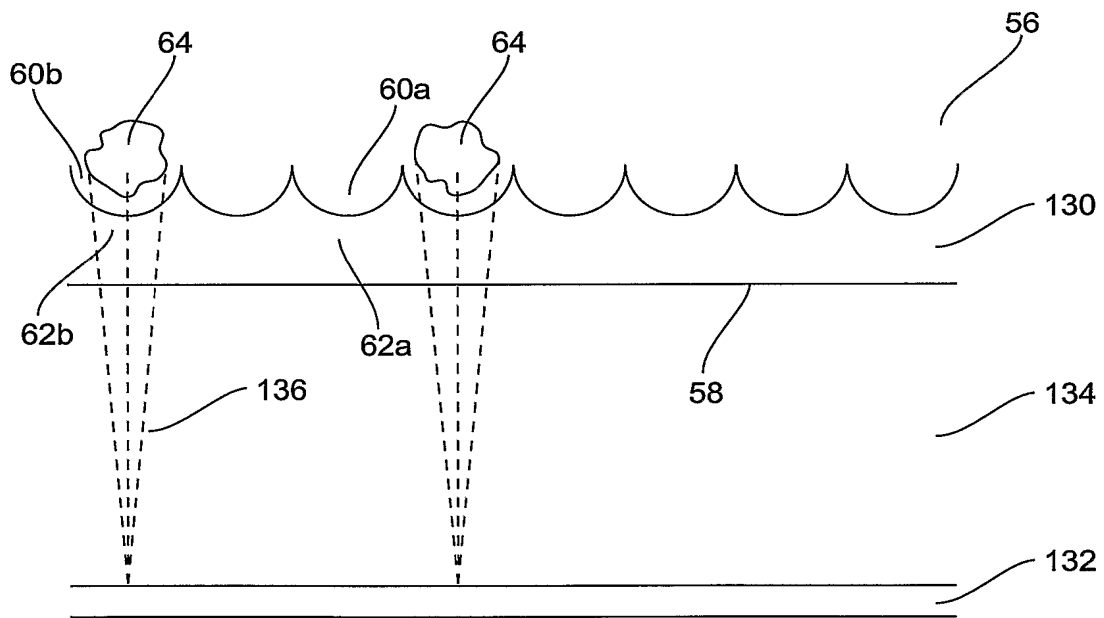

FIG.20

INTERNATIONAL SEARCH REPORT

nal Application No
rC I / iL . 2005 / 000719

A. CLASSIFICATION OF SUBJECT MATTER
IPC 7 G01N15/14

According to International Patent Classification (IPC) or to both national classification and IPC

B. FIELDS SEARCHED
Minimum documentation searched (classification system followed by classification symbols)
IPC 7 GOIN

Documentation searched other than minimum documentation to the extent that such documents are included in the fields searched

Electronic data base consulted during the international search (name of data base and where practical, search terms used)
EPO-Internal , PAJ, INSPEC

C. DOCUMENTS CONSIDERED TO BE RELEVANT

Category *	Citation of document, with indication where appropriate, of the relevant passages	Relevant to claim No
X	WO 03/035824 A (BAR-ILAN UNIVERSITY; DEUTSCH, MORDECHAI) 1 May 2003 (2003-05-01) cited in the application the whole document -----	1-95
X	WO 98/35223 A (COMPUCYTE CORP) 13 August 1998 (1998-08-13) the whole document -----	1-95
X	WO 98/15356 A (MOLECULAR DRIVES LIMITED; GORDON, JOHN, FRANCIS) 16 April 1998 (1998-04-16) abstract; figures 1, 2d, 5 -----	1-75, 78-95
Y	US 5 428 451 A (LEA ET AL) 27 June 1995 (1995-06-27) the whole document -----	76, 77
Y	US 5 428 451 A (LEA ET AL) 27 June 1995 (1995-06-27) the whole document -----	76, 77
	-/--	

Further documents are listed in the continuation of box C Patent family members are listed in annex

° Special categories of cited documents

"A" document defining the general state of the art which is not considered to be of particular relevance

"E" earlier document but published on or after the international filing date

"L" document which may throw doubts on priority claim(s) or which is cited to establish the publication date of another citation or other special reason (as specified)

"O" document referring to an oral disclosure, use, exhibition or other means

"P" document published prior to the international filing date but later than the priority date claimed

"T" later document published after the international filing date or priority date and not in conflict with the application but cited to understand the principle or theory underlying the invention

"X1" document of particular relevance, the claimed invention cannot be considered novel or cannot be considered to involve an inventive step when the document is taken alone

"Y" document of particular relevance, the claimed invention cannot be considered to involve an inventive step when the document is combined with one or more other such documents, such combination being obvious to a person skilled in the art

"&" document member of the same patent family

Date of the actual completion of the international search 7 November 2005	Date of mailing of the international search report 15/11/2005
--	--

Name and mailing address of the ISA European Patent Office P B 5818 Patentlaan 2 NL - 2280 HV Rijswijk Tel (+31-70) 340-2040, Tx 31 651 epo nl, Fax (+31-70) 340-3016	Authorized officer Jakober , F
---	---------------------------------------

INTERNATIONAL SEARCH REPORT

International Application No
ru/IL2005/000719

C.(Continuation) DOCUMENTS CONSIDERED TO BE RELEVANT		
Category °	Citation of document, with indication, where appropriate, of the relevant passages	Relevant to claim No
A	WO 99/45357 A (TRUSTEES OF TUFTS COLLEGE; WALT, DAVID, R; TAYLOR, LAURA) 10 September 1999 (1999-09-10) the whole document -----	1-95
A	US 6 103 479 A (TAYLOR ET AL) 15 August 2000 (2000-08-15) the whole document -----	1-95

INTERNATIONAL SEARCH REPORT

Information on patent family members

inal Application No r u i / 1L2005/000719
--

Patent document cited in search report	Publication date	Publication date	Patent family member(s)	Publication date
wo 03035824	A	01-05-2003	EP 1438385	Al 21-07-2004
			JP 2005506083	T 03-03-2005
			US 2005014201	Al 20-01-2005
wo 9835223	A	13-08-1998	AU 6327798	A 26-08-1998
			CA 2280154	Al 13-08-1998
			EP 1007949	Al 14-06-2000
			JP 2001512569	T 21-08-2001
			US 5885840	A 23-03-1999
wo 9815356	A	16-04-1998	AT 234154	T 15-03-2003
			AU 724660	B2 28-09-2000
			AU 4564297	A 05-05-1998
			CN 1239905	A 29-12-1999
			DE 69719782	DI 17-04-2003
			DE 69719782	T2 25-03-2004
			EP 0938382	Al 01-09-1999
			NZ 335863	A 24-11-2000
us 5428451	A	27-06-1995	AU 650433	B2 23-06-1994
			AU 6757990	A 18-07-1991
			CA 2071838	Al 08-06-1991
			DE 69007118	DI 07-04-1994
			DE 69007118	T2 09-06-1994
			DK 504185	T3 28-03-1994
			wo 9109297	Al 27-06-1991
			EP 0504185	Al 23-09-1992
			JP 5501609	T 25-03-1993
wo 9945357	A	10-09-1999	AT 268809	T 15-06-2004
			AU 744543	B2 28-02-2002
			AU 3065199	A 20-09-1999
			CA 2321558	Al 10-09-1999
			DE 69917888	DI 15-07-2004
			DE 69917888	T2 23-06-2005
			EP 1060239	A2 20-12-2000
			JP 3471753	B2 02-12-2003
			JP 2002506200	T 26-02-2002
			US 6210910	BI 03-04-2001
			US 6667159	BI 23-12-2003
us 6103479	A	15-08-2000	NONI	